

Ancon®

Wall Ties and Restraint Fixings

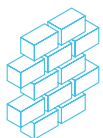
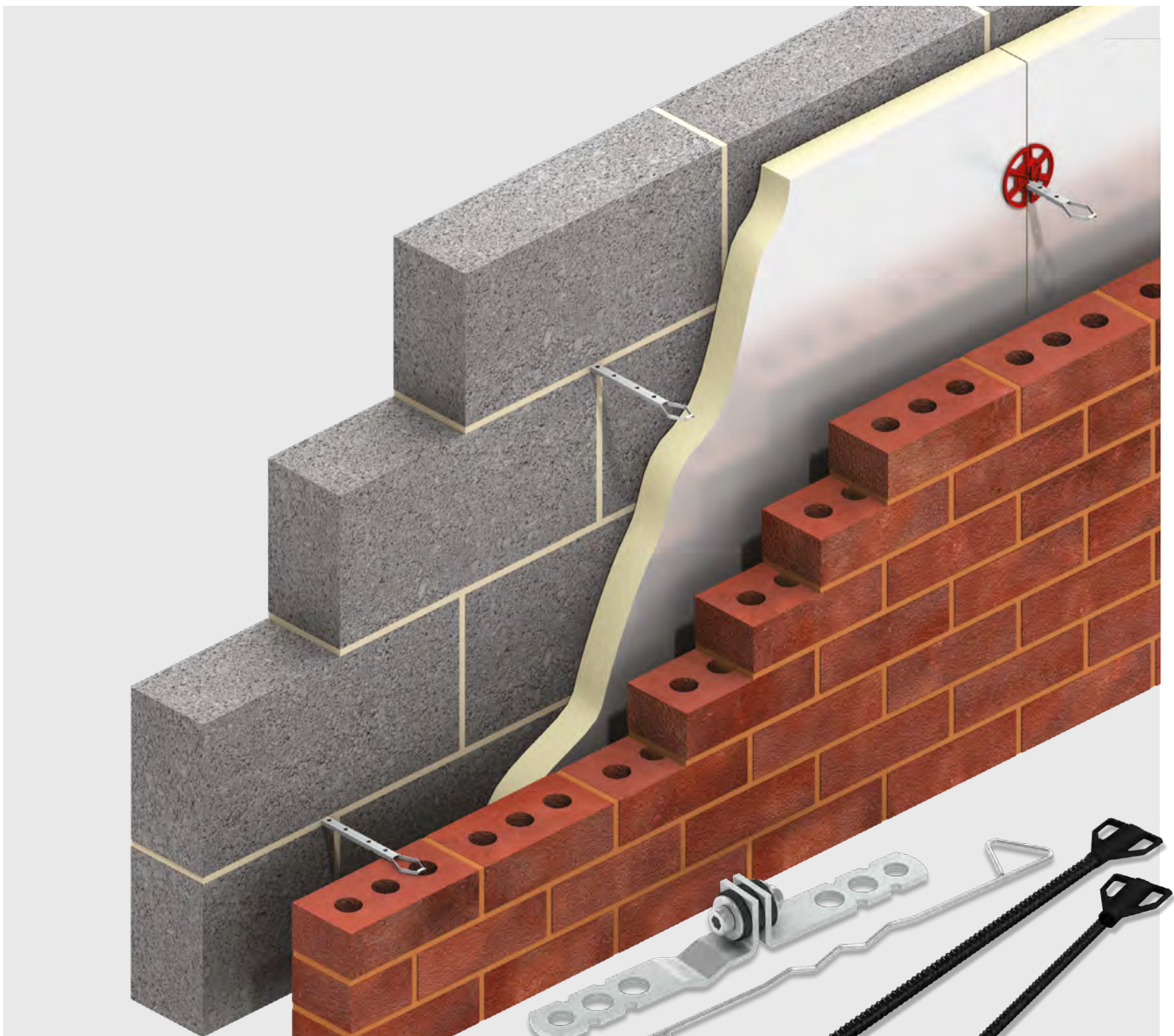

Façade Support & Restraint
Wall Ties & Restraints

Leviat

We imagine, model and make engineered products and innovative construction solutions that help turn architectural visions into reality and enable our construction partners to build better, safer, stronger and faster.



Façade Support & Restraint

Systems for the safe and thermally-efficient fixing of the external building envelope, including brick and natural stone, insulated sandwich panels, curtain walling and suspended concrete façades, and also the repair and strengthening of existing masonry installations.

- Masonry Support Systems
- Windposts
- Lintels
- Brick Slip Systems
- Wall Ties & Restraints
- Masonry Reinforcement
- Natural Stone Façade Systems
- Cavity Trays
- Sandwich Panel anchor
- Suspended concrete façade
- Masonry Repair

Other areas of expertise:



Structural Connections

Systems to form robust, efficient connections, and continuity of concrete reinforcement as necessary, between walls, slabs, columns, beams and balconies, providing structural integrity as well as enhanced thermal and acoustic performance.

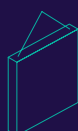

Lifting & Bracing

Systems for the safe and efficient transportation, lifting and temporary bracing of cast concrete elements and tilt-up panels before permanent structural connections are made.



Anchoring & Fixing

Systems for fixing secondary fixtures to concrete, including anchor channels, bolts and inserts; also tension rod systems for roofs and canopies.



Formwork & Site Accessories

Non-structural accessories that complement our engineered solutions and help keep your construction environment operating safely and efficiently, including moulds for casting standard and special concrete elements and construction essentials such as reinforcing bar spacers.

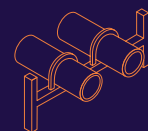

Industrial Technology

Mounting channels, pipe clamps and other versatile framing systems that provide safe fixing in a wide range of industrial applications.

Leviat product ranges:

Ancon | Aschwanden | Connolly | Halfen | Helifix | Isedio | Meadow Burke | Modersohn | Moment | Plaka | Scaldex | Thermomass

Product Approvals & Certifications

The table below outlines the relevant product markings applicable to each product in our Wall Tie & Restraint Fixings range. For full details, please refer to the documentation provided or contact our technical support team. Declarations of Performance (DoP) can be downloaded from www.ancon.co.uk/approvals

UKCA Marking

The UKCA (UK Conformity Assessed) marking is the new UK product marking that will be used for goods being placed on the market in Great Britain.

CE UKNI Marking

The UKNI marking is a new conformity marking for products placed on the market in Northern Ireland which will be used on products that have undergone mandatory third-party conformity assessment by a body based in the UK.

CE Marking

The CE mark is the conformity marking for products placed on the market in Europe.

Product	UKCA	CE UKNI	CE	NBS Plus	CAD Details	BIM
HRT4	✓	-	✓	✓	✓	✓
RT2	✓	-	✓	✓	✓	✓
ST1	✓	-	✓	✓	✓	✓
Two-Part Tie	✓	✓	-	✓	✓	✓
SDB 125-300mm	✓	-	✓	✓	-	✓
SDB 301-450mm	✓	-	✓	-	-	-
SDS 150-300mm	✓	-	✓	-	-	-
SDS 301-525mm	✓	-	✓	-	-	-
SPB 75-300mm	✓	-	✓	✓	✓	✓
PPS 150-300mm	✓	-	✓	✓	✓	✓
PPB 125-225mm	✓	-	✓	✓	✓	✓
SPV 75-300mm	✓	-	✓	✓	✓	-
PPV 125-225mm	✓	-	✓	✓	✓	-
Staifix Cavity Starter Tie	✓	-	✓	✓	✓	-
Staifix Frame Tie	✓	✓	-	✓	✓	-
Staifix Starter Tie	✓	-	✓	✓	✓	-
STF6 50, 75, 100mm	✓	✓	-	✓	✓	-
TJ2 205, 230, 255, 280, 305mm long	✓	✓	-	✓	✓	-
SD21, 25, 28 100-300mm	✓	-	✓	✓	-	21, 25
SP21, 28, 30, 36, 38 75-200mm	✓	-	✓	✓	-	21
DT 150-250mm	✓	-	✓	✓	-	-
DT 300mm	✓	-	✓	✓	-	-
SPS 150-300mm	✓	-	✓	✓	-	-
SPS CJ 150mm	✓	-	✓	✓	-	-
TFMT7 50-150mm cavity	✓	-	✓	✓	-	-
TIM6 175, 200, 225, 250mm	✓	-	✓	✓	-	-
PP21 125-225mm	✓	-	✓	✓	-	-
PP28, 30, 36, 38 125-300mm	✓	-	✓	✓	-	-
SD30, 38, 40 125-300mm	✓	-	✓	✓	-	-
SDV 125-300mm	✓	-	✓	✓	-	-
Briclok	✓	✓	-	✓	-	-
Column Tie 125-300mm	✓	✓	-	✓	-	-
HiT Tie	✓	✓	-	✓	-	-
Internal Column Tie 179, 186, 224 and 232mm	✓	✓	-	✓	-	-
WHX 150-200mm	✓	✓	-	✓	-	-
Y, M, L, D, Z End Ties	✓	✓	-	✓	✓	-

Ancon Wall Ties and Restraint Fixings

Contents

Cavity Wall Tie Selection	6-9
Installation Guidance	10
Ties for Brick-to-Block Construction	11-14
Two Part Ties	14
Ties for Bubble Foil Insulation	15
Ties for Steel Studwork	16
Ties for Thin-Joint Blockwork	17-18
Ties for Timber Frames	19-20
Frame Cramps and Channel Ties	20-27
Vertical Movement Joints	28
Standard Wall Ties	29-30
Bespoke Wall Tie References	31
Insulation Retaining Clips	32-33
Non-Drill Fixings for Steelwork	34-35
Head Restraints & Sliding Anchors	36-39
Acoustic Wall Ties	40-41
Wall Starter Systems	42
Restraints for Stone Cladding	43
Remedial Wall Ties	45-46
Staifix-Thor Helical Crack Stitching Kit	47
Other Ancon Products	47

For building with brick, block and stone

Wall ties and restraint fixings are an essential element in the stability of masonry panels.

Leviat manufactures Ancon Restraint Ties in a variety of lengths and types for restraining brickwork, blockwork and stonework. Restraints can be fixed to a variety of substrates including concrete, structural steelwork, SFS, timber and all types of masonry.

Products are manufactured from stainless steel unless stated otherwise.

The range of standard ties provides a solution for all types of wall construction and many products can be delivered in 24 hours. These items are shown in **red**.



Dedicated sales and technical support



Distributors nationwide



CPD Seminars available



BIM Objects available



UKCA and CE or CE UKNI Compliance



Webinars available online

Building Information Modelling

A number of Ancon wall ties are available as BIM Objects for use in a 3D building model and its associated component database. Visit www.ancon.co.uk/BIM or NBS Source to download our objects in Revit, IFC, ArchiCAD, Vectorworks and Bentley file formats.

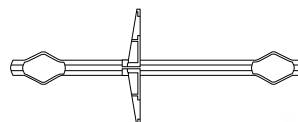



Ancon Wall Ties and Restraint Fixings



© Hazle McCormack Young

Cavity Wall Tie Selection

The selection and spacing of wall ties depend on many factors. These include type of masonry to be tied, cavity width, type and height of building and geographical location. There are several documents which need to be consulted and are summarised here.

Eurocode 6 – Design of Masonry Structures (BS EN 1996-1-1: 2005)

In 2010, Eurocode 6 became the main code for the design of reinforced and unreinforced masonry. Eurocode 6 refers to EN 845-1 for wall ties and sets the density of ties per square metre based on the declared value of the tie. The material factor of 3.0 for detailed calculations is specified in the UK National Annex.

BS EN 845-1: 2013 Specification for Ancillary Components for Masonry – Part 1: Wall Ties, Tension Straps, Hangers and Brackets

This European Standard specifies the requirements for wall ties used for interconnecting masonry and for connecting masonry to beams, columns or other parts of the building. Materials, tolerances, tie variations and the requirements for declared values, are all covered in this standard. For tie types and qualifying criteria refer to PD 6697: 2019.

PD 6697: 2019 Recommendations for the design of masonry structures to BS EN 1996-1-1 and BS EN 1996-2

Published Document 6697 contains non-contradictory, complementary information from the withdrawn British Standard BS 5268, which was not included in the BS EN 1996 series.

It includes recommendations on tie lengths, embedment, density, material and positioning. Masonry-to-masonry ties are classified as Types 1 to 4; the relevant classification is determined by strength, function and use. Minimum declared values for tension and compression are listed on pages 7-8 for each tie type.

Approved Document E: Resistance to the Passage of Sound

This document specifies the acoustic performance requirements of ties suitable for use in separating walls (Type A) and external walls (Type B) of new build dwellings.

Type A ties must have a measured dynamic stiffness of $<4.8\text{MN/m}^3$ for the specified minimum cavity, at a standard density. Type A ties in this literature are indicated by this logo e.g. Ancon Staifix HRT4, page 11.

All Ancon Ties which cross a cavity meet the requirements of Type B.



© Green Building Store



© Irvine Whitlock



BS 5268, Code of Practice for the Use of Masonry

BS 5268 was withdrawn when the Eurocode became the accepted National code in March 2010. The majority of information in this British Standard has been reproduced in PD 6697: 2019.

BS 5268-6.1: 1996 (Incorporating Amendments No. 1 and 2): Structural use of timber – Dwellings not exceeding seven storeys

BS 5268 provides recommendations for wall ties for timber framed buildings. Information is provided for the type of structure, location, embedment, density and positioning. These ties are classified as Types 5 to 7; minimum declared values in tension and compression are listed for Types 5 and 6.

Although BS 5268 was officially withdrawn on the full implementation of Eurocodes in March 2010, timber frame wall ties should continue to be selected from Types 5 to 7 as given in Annex B of BS 5268 Part 6.1: 1996, until further guidance is made available.

Wind Code Variations

Masonry wall ties should be selected from the Types in PD 6697: 2019 and timber frame wall ties should be selected from the Types in BS 5268. These two documents use different Wind Codes.

The maximum wind speeds referred to in PD 6697: 2019 are based on ten minute return periods according to the current Wind Code BS EN 1991-1-4: 2005.

The geographical locations in BS 5268-6.1 are based on hourly return period wind speeds according to BS 6399-2: 1997.

Wall tie types and appropriate wind speed maps relevant to each wind code are shown on pages 7-8. However we encourage specifiers to refer to the relevant code for complete information prior to making a specification.

Wall Tie Product Selector

Available on our Ancon website, this easy to use product selector enables selection of the most appropriate wall ties for your application. Simply answer a series of multiple choice questions about wall type, inner leaf construction, building type and height, insulation and cavity width, to arrive at the required solution.

https://www.ancon.co.uk/product_selectors

**Minimum Requirements for Wall Ties to PD 6697: 2019 (Table 12)
and BS 5268-6.1:1996 (Annex B)**

Type of Tie	Minimum Mortar Class and Designation	Tensile Load Capacity (N)	Compressive Load Capacity (N)
1	M2 (iv)	2500	2000
2	M2 (iv)	1800	1050
3	M2 (iv)	1100	650
4	M2 (iv)	650	350
5	M4 (iii)	600	425
6	M4 (iii)	630	440
7	M4 (iii)	To be declared by the Wall Tie Manufacturer	

Lime Mortars

Ancon Stainless Steel Wall Ties and Ancon Teplo-BF Wall Ties are suitable for use with lime mortars (minimum strength HLM2); tie selection should be based on the general guidance given here.

Masonry-to-Masonry Wall Tie Types to PD 6697:2019

Type of Tie	Application	Density	Maximum Building Height	Geographical Location
1	Heavy duty tie suitable for most building sizes and types. Not very flexible and not recommended for applications where there is expected to be excessive differential movement between leaves.	2.5 ties/m ² 3-4 ties/m ² at unbonded edges	Any height	Suitable for most sites. However, for relatively tall or unusually shaped buildings in vulnerable areas such as coastal sites, the tie provision should be calculated.
2	General purpose tie for domestic and small commercial buildings made with box-form masonry walls.	As Type 1	15m	Suitable for flat (less than 1 in 20) open sites where the fundamental basic wind velocity does not exceed 31m/s and altitude is not more than 150m above sea level. Could be adequate for higher altitudes and sloping sites exceeding 1 in 20, if calculated.
3	Basic wall tie generally as Type 2 above.	As Type 1	15m	As Type 2 but fundamental basic wind velocity limited to 27m/s
4	Light duty wall tie suitable for box-form domestic dwellings with leaves of similar thickness.	As Type 1	10m	Suitable for flat sites (less than 1 in 20) in towns and cities where the fundamental basic wind velocity does not exceed 27m/s and altitude is not more than 150m above sea level.

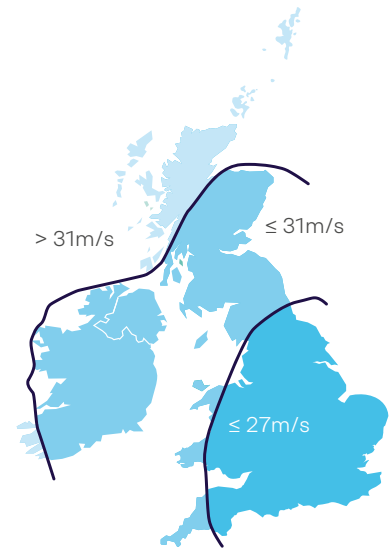

Information adapted from NA to BS EN 1991-1-4:2005 for use with PD 6697:2019, calculating c_{alt} for an altitude of 150m above sea level. For some projects this may be conservative. Contact Leviat for further details.

Note: Fundamental basic wind velocity must be calculated for the specific altitude of the site, refer to Clause NA.2.4 in NA to BS EN 1991-1-4:2005. The table above provides only a brief summary of information. Refer to PD 6697:2019 and NA to BS EN 1991-1-4:2005 for complete information.



Ancon Wall Ties and Restraint Fixings

Masonry-to-Timber Wall Tie Types to BS 5268-6.1:1996

Type of Tie	Application	Density	Maximum Building Height	Geographical Location
5	Timber frame tie suitable for domestic houses and industrial/ commercial developments of up to three storeys.	4.4 ties/m ² 3-4 ties/m ² at unbonded edges	15m	Suitable (at a density of 4.4 ties/m ²) for buildings on flat sites in towns and cities where the basic wind speed does not exceed 25m/s and altitude is not more than 150m above sea level. In more severe situations the tie density should be increased to 7 ties/m ² .
6	As Type 5 but suitable for developments of up to four storeys.	As Type 5	15m	As type 5.
7	As Type 5 but suitable for developments of between five and seven storeys, being designed to accommodate the increased vertical differential movement.	Calculated for actual performance required for each site location.	18m	Calculated for actual performance required for each site location.

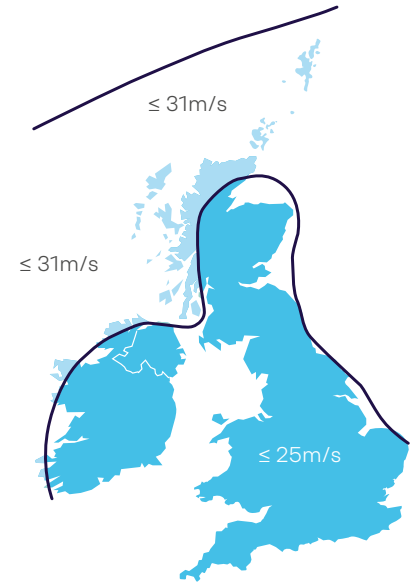

Wind speed information taken from BS 6399-2:1997 Code of Practice for Wind Loads for use with BS 5268-6.1:1996.

Note: Refer to BS 5268-6.1: 1996 and BS 6399-2: 1997 for complete information.

Ancon Teplo-BFL-Tie (Type 6)

Ancon Staifix-Thor Helical TIM6 (Type 6)

Ancon Staifix STF6 (Type 6)

Ancon Timber Frame Movement Tie, TFMT7 (Type 7)



Density & Positioning of Ties

PD 6697: 2019 recommends that for walls in which both leaves are 90mm or thicker, ties should be used at not less than 2.5 per square metre (900mm horizontal x 450mm vertical centres). Ties should be evenly distributed over the wall area, except around openings, and should preferably be staggered.

At vertical edges of an opening, unreturned or unbonded edges, and vertical expansion joints, additional ties should be used at a rate of one per 300mm height, located not more than 225mm from the edge.

A typical layout is shown below. Various details incorporating debonding ties at vertical movement joints are shown on page 28.

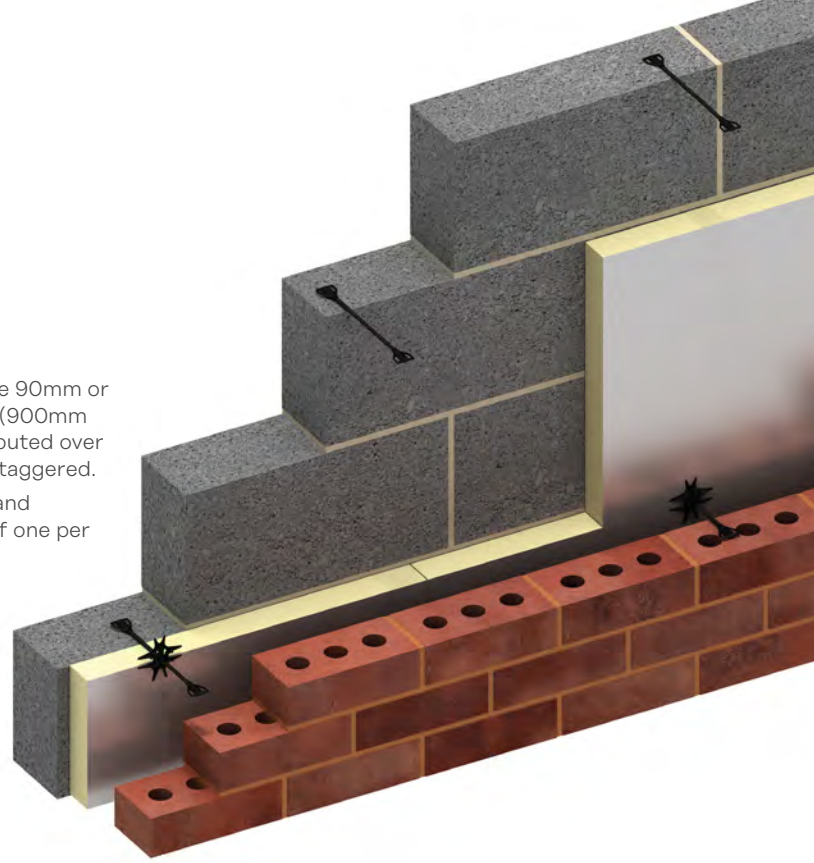

Lime Mortars

Ancon Stainless Steel Wall Ties and Ancon Teplo-BF Wall Ties are suitable for use with lime mortars (minimum strength HLM2). Tie length, spacing and density should be the same as for cement mortars where the performance is based on M2 (iv).

Typical Layout of Wall Ties Indicating Maximum Spacing

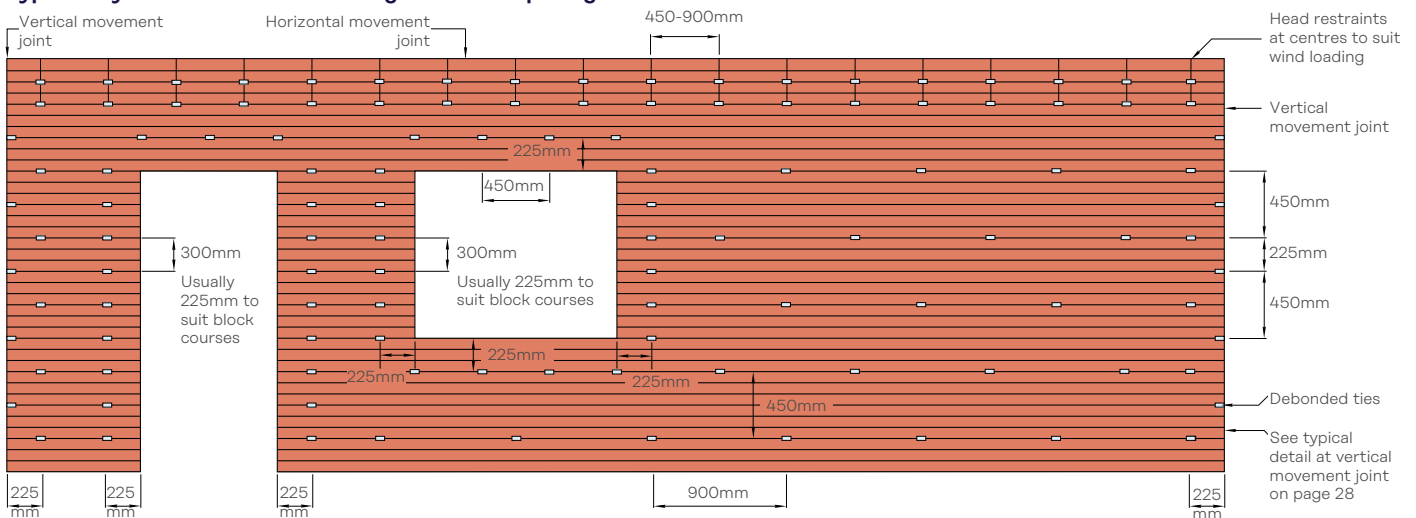

Standard spacing for cavity brickwork 900mm x 450mm centres in a staggered pattern (2.5 ties per square metre) Refer to PD 6697:2019 for complete information.

Length of Tie & Embedment

Wall ties should be of the correct length to ensure they are properly embedded in the masonry.

Masonry-to-masonry wall ties are typically symmetrical and should be centred from the middle of the cavity to ensure equal embedment in each leaf.

The minimum embedment of symmetrical Ancon Wall Ties, i.e. ST1, RT2, HRT4 and Teplo-BF, is 50mm in each leaf and the PD 6697: 2019 Tie Types declared by us are backed by independent testing at this minimum embedment.

However, we recommend tie lengths which achieve a design embedment of between 62.5mm and 75mm in each leaf (see table), to allow for site tolerance in both cavity width and centring of the ties.

Cavity width on site should be monitored to ensure the correct wall tie length is used. If the cavity width grows to such an extent that the embedment range of the wall tie is exceeded, longer wall ties will be required. Please contact us for guidance.

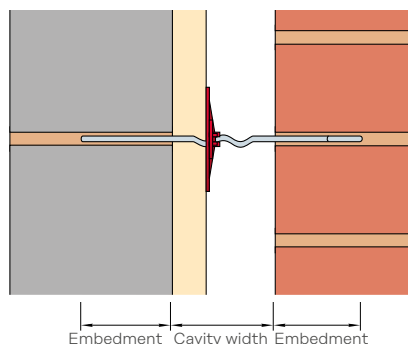

Embedment of Wall Ties

Recommended Lengths of Masonry/Masonry Wall Ties

Cavity Width (mm)	Length of Wall Tie (mm)
50-75	200
76-100	225
101-125	250
126-150	275
151-175	300
176-200	325
201-225	350
226-250	375
251-275	400
276-300	425
301-325	450
326-350	475
351-375	500
376-400	525
401-425	550
426-450	575

Ancon Wall Ties and Restraint Fixings

Installation Guidance

Wall ties are important to the stability of masonry and failure to install them correctly may lead to damp penetration, cracking or even the collapse of walls.

Wall ties should be pressed down in fresh mortar. They should be surrounded by mortar and not simply positioned directly onto masonry with mortar placed around them. To ensure cavity wall ties are effective at tying the leaves together they should be installed as the inner leaf is constructed and not simply pushed into a joint.

Ideally, ties should be installed level or with a slight fall to the outer leaf, not towards the inner leaf as this could provide a path for moisture to cross the cavity.

The drip part of the tie should point downward and be positioned near the centre of the open cavity. Ties with multiple drips, like the Ancon Staifix HRT4 and Ancon ST1, should be positioned centrally as a drip will normally be near the centre of the open section of a partial fill cavity.

Installed ties should be clear of mortar droppings to allow the drip to function and prevent water from crossing to the inner leaf of masonry.

The practice of bending up installed wire ties should be discouraged. This can adversely affect the performance of the

tie and weaken the embedment in the inner leaf. Rigid ties like the Ancon SDS and ST1 should never be bent on site.

There is a risk of injury if wall ties are left protruding from a single wall leaf before the second leaf is constructed. Site managers should make all workers and visitors aware of this risk.

Installation guides can be downloaded from www.ancon.co.uk/resources/installation-guides

To reduce the risk of injury, Ancon Wall Ties feature rounded safety ends, however, we recommend both leaves of a cavity wall are built simultaneously to eliminate any risk of injury from protruding ties.

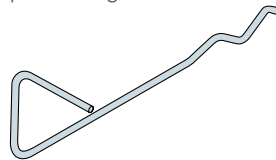

Ancon Staifix Safety End

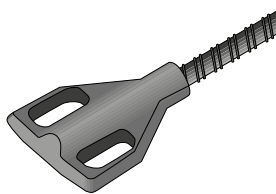

Ancon Teplo-BF Moulded Safety End

Ancon Frame Ties and Channel Ties are manufactured with a non-spread safety end allowing the use of a debonding sleeve. This type of safety end reduces the variety of ties required on site.

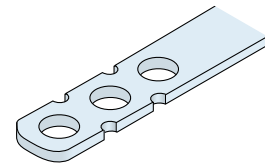

Ancon Non-Spread Safety End

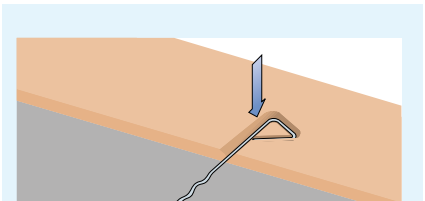

Wall ties should be pressed down in, and then surrounded by, fresh mortar.

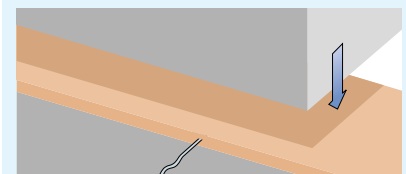

To ensure cavity wall ties are effective at tying the leaves together they should be installed as the inner leaf is constructed and not simply pushed into a joint.

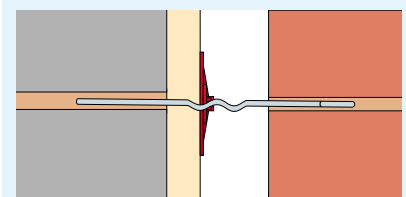

Ties should be installed with a slight fall to the outer leaf, never towards the inner leaf as this could provide a path for moisture to cross the cavity.



Ancon Wall Ties with Insulation Retaining Clips

Low Thermal Conductivity Wall Ties to PD 6697: 2019 for Brick-to-Block Construction

Ancon ST1 Type 1 Tie (Masonry Heavy Duty)

The Ancon ST1 is suitable for cavities from 50mm to 225mm and can be used for all types of buildings of any height, anywhere in the British Isles. The section that spans the cavity has a series of holes to provide water drips. The Ancon ST1 has a measured dynamic stiffness of $<113\text{MN/m}^3$ that meets the performance requirement of Approved Document E for use in external masonry walls. For internal separating walls of new-build attached dwellings see Ancon Staifix HRT4. Type 1 performance is declared in M2 mortar.

Ancon Staifix RT2 Type 2 Tie (Masonry General Purpose)

The Ancon Staifix RT2 is a general purpose tie. It is suitable for cavities from 50mm to 150mm and can be used for domestic houses and small commercial buildings up to 15 metres in height (see pages 7-8 for geographical restrictions). In many cases, Ancon Staifix RT2 Wall Ties can be used in buildings greater than 15 metres if shown to be adequate by calculation. For further information please contact our Technical Services Team. The Ancon Staifix RT2 has a measured dynamic stiffness of $<113\text{MN/m}^3$ that meets the performance requirement of Approved Document E for use in external masonry walls. For internal separating walls of new-build attached dwellings see Ancon Staifix HRT4.

Ancon Staifix HRT4 Type 4 / Type A Tie (Masonry Light Duty)

The Ancon Staifix HRT4 is available for cavities from 50mm to 175mm. As a Type 4 tie it is suitable for use in external walls of domestic houses up to 10 metres in height (see pages 7-8 for geographical restrictions).

The HRT4 is a Type A tie for separating walls of any height. Independent tests have proven the Ancon Staifix HRT4 has a measured dynamic stiffness of $<4.8\text{MN/m}^3$ when installed at a standard 2.5 ties/m² spacing and is therefore suitable for internal separating (party) walls of new-build attached dwellings with cavities from 50mm to 175mm. The Ancon Staifix HRT4 can be used with all approved robust details for cavity masonry separating walls, whether traditional or thin-joint blockwork (suitable for thin-joint construction with 3mm thick joints up to a 150mm cavity). Use of these details eliminates the need for pre-completion sound testing. For wall ties with greater acoustic resilience, see page 40-41.

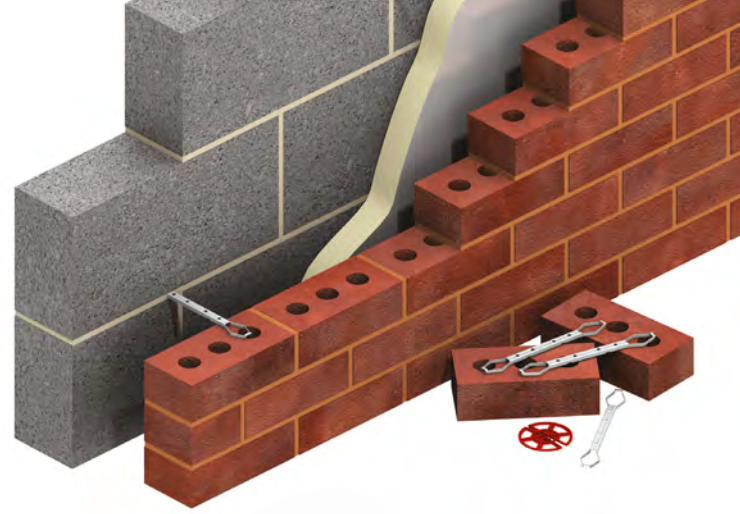

Ancon ST1, Stainless Steel

- 200mm for 50-75mm cavities
- 225mm for 76-100mm cavities
- 250mm for 101-125mm cavities
- 275mm for 126-150mm cavities
- 300mm for 151-175mm cavities
- 325mm for 176-200mm cavities
- 350mm for 201-225mm cavities



Ancon Staifix RT2, Stainless Steel

- 200mm for 50-75mm cavities
- 225mm for 76-100mm cavities
- 250mm for 101-125mm cavities
- 275mm for 126-150mm cavities

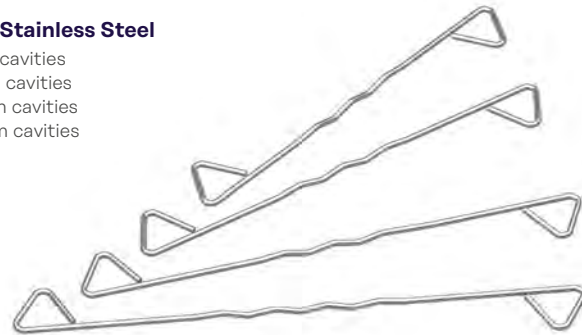

Ancon Staifix HRT4, Stainless Steel

- 200mm for 50-75mm cavities
- 225mm for 76-100mm cavities
- 250mm for 101-125mm cavities
- 275mm for 126-150mm cavities
- 300mm for 151-175mm cavities

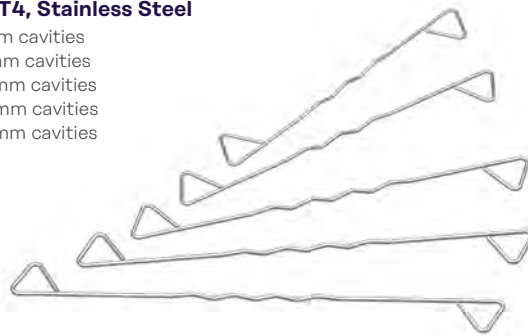

Ancon Wall Ties and Restraint Fixings

Ancon Teplo-BF

The Ancon Teplo-BF is suitable for cavities from 50mm to 450mm and is manufactured from pultruded basalt fibres. This material has a thermal conductivity of only 0.7W/mK which can be shown in U-value calculations to reduce insulation thickness and wall footprint.

The Ancon Teplo-BF range comprises Teplo-BF1 (Type 1), Teplo-BF2 (Type 2), Teplo-BF3 (Type 3) and Teplo-BF4 (Type 4). Please refer to pages 7-8 for further details on the suitability of each wall tie at the standard spacings. Decreasing wall tie centres can increase performance level e.g Type 3 to Type 2. Contact us for more information.

The Ancon Teplo range has BBA approval and can be used in line with NHBC standards. It also meets the performance requirement of Approved Document E for use in external masonry walls. For internal separating walls of new-build attached dwellings use Ancon Staifix HRT4.

Plain-ended Ancon Teplo-R ties, inspired by the original basalt-fibre wall tie, are ideal for resin-fixed remedial/ retrofit projects.

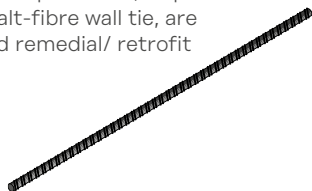

Also available is the Ancon Teplo-BFR featuring a plain end for anchoring with resin and a moulded safety end for building into a bed joint. This product is ideal for use when mortar joints do not align or when a new leaf of masonry is being added to an existing masonry or concrete structure.

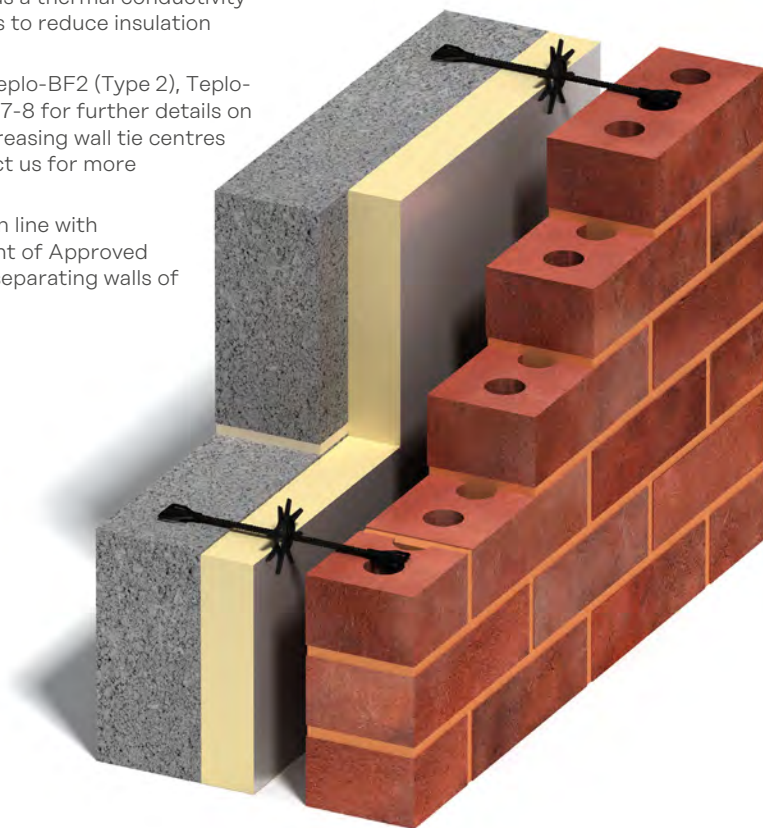
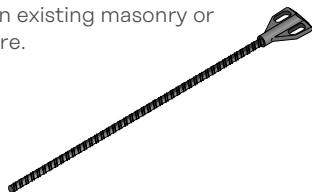

Ancon Teplo-BF is available in a range of diameters and lengths to suit cavities from 50mm to 450mm

Low Thermal Conductivity Wall Ties

Wall ties are an essential element in the strength and stability of cavity walls, but by crossing the cavity they act as a thermal bridge between the internal and external leaves. The ties featured here on pages 11-13 form our Ancon Low Thermal Conductivity range; cavity ties which minimise heat loss and improve the energy-efficiency of a masonry wall. With a thermal conductivity of only 0.7W/mK, Ancon Teplo Wall Ties are the most thermally-efficient products in the range and are excluded from U-value calculations to BS EN ISO 6946.

For the accurate calculation of a wall's U-value it is important to use the correct information for the wall ties. Using the actual cross-sectional area and thermal conductivity value of a wall tie, rather than allowing a program to apply default values, can make a considerable difference to the calculated U-value. Default values will over-estimate the effect of an Ancon Wall Tie. The effect our high tensile wire wall ties have on heat transfer is negligible.

Ancon Teplo-BF1/2/4, Basalt-Fibre

200mm for 50-75mm cavities
 225mm for 76-100mm cavities
 250mm for 101-125mm cavities

Ancon Teplo-BF1/2, Basalt-Fibre

275mm for 126-150mm cavities

Ancon Teplo-BF2, Basalt-Fibre

300mm for 151-175mm cavities
 325mm for 176-200mm cavities
 350mm for 201-225mm cavities
 375mm for 226-250mm cavities
 400mm for 251-275mm cavities
 425mm for 276-300mm cavities

Ancon Teplo-BF3, Basalt-Fibre

450mm for 301-325mm cavities
 475mm for 326-350mm cavities
 500mm for 351-375mm cavities
 525mm for 376-400mm cavities

Ancon Teplo-BF4, Basalt-Fibre

550mm for 401-425mm cavities
 575mm for 426-450mm cavities

**Cross-Sectional Areas and Thermal Conductivity of Ancon Wall Ties**

Tie Reference	Tie Length (mm)	Cavity Width (mm)	Tie Type to PD 6697:2019	Area (mm ²)	Thermal Conductivity* (W/mK)
ST1	200	50-75	1	19.5	17
	225	76-100	1	19.5	17
	250	101-125	1	19.5	17
	275	126-150	1	23.4	17
	300	151-175	1	23.4	17
	325	176-200	1	23.4	17
	350	201-225	1	23.4	17
RT2	200	50-75	2	7.6	17
	225	76-100	2	7.6	17
	250	101-125	2	8.6	17
	275	126-150	2	10.2	17
HRT4	200	50-75	4	3.5	17
	225	76-100	4	4.2	17
	250	101-125	4	4.9	17
	275	126-150	4	6.2	17
	300	151-175	4	7.6	17
Teplo-BF1	200	50-75	1	38.5	0.7
	225	76-100	1	38.5	0.7
	250	101-125	1	38.5	0.7
	275	126-150	1	38.5	0.7
Teplo-BF2	200	50-75	2	19.6	0.7
	225	76-100	2	19.6	0.7
	250	101-125	2	19.6	0.7
	275	126-150	2	28.3	0.7
	300	151-175	2	28.3	0.7
	325	176-200	2	28.3	0.7
	350	201-225	2	38.5	0.7
	375	226-250	2	38.5	0.7
	400	251-275	2	38.5	0.7
	425	276-300	2	38.5	0.7
Teplo-BF3	450	301-325	3	38.5	0.7
	475	326-350	3	38.5	0.7
	500	351-375	3	38.5	0.7
	525	376-400	3	38.5	0.7
Teplo-BF4	200	50-75	4	12.6	0.7
	225	76-100	4	12.6	0.7
	250	101-125	4	12.6	0.7
	550	401-425	4	38.5	0.7
	575	426-450	4	38.5	0.7

Note: BS EN ISO 6946 permits the corrections due to wall ties, air gaps etc to be omitted, if the corrections amount to less than 3% of the uncorrected U-value of the element. *Wall Ties with a thermal conductivity of less than 1.0W/mK e.g. Teplo, are excluded from U-value calculations to BS EN ISO 6946, irrespective of cross-sectional area.'

Ancon Wall Ties and Restraint Fixings

Ancon Two-Part Tie

Long ties for cavities of 150mm and above can often be difficult to balance and keep horizontal when built into the inner leaf. As an alternative, our Ancon Two-Part Tie has one section built into the blockwork and a second section is then fixed as the outer leaf is built. An embedment of 75mm is required at each end. The inner tie is usually manufactured in lengths of 170mm with variation in the cavity width being accommodated by the length of the outer section. Where insulation thickness is in excess of 60mm, the inner section should be longer than the standard 170mm to ensure the connection between the two parts is made in the open cavity.

To specify or order this tie simply quote 'Ancon Two-Part Tie to suit ___mm cavity with an insulation thickness of ___mm'. The black Teplo insulation Retaining Clip is recommended for use with the inner section.

Using the standard inner section, Ancon Two-Part Ties sustain loads which exceed the requirements for a Type 2 tie to PD 6697: 2019 for cavities up to 400mm.

Recommended Fixing Centres for Two-Part Ties

Inner Section (mm)	Cavity (mm)	Type 1	Type 2	Type 3
170	150-400	600x450	900x450	900x450
171-230	150-400	375x450	750x450	900x450

Notes: Centres shown achieve equivalent tie type performances to PD 6697:2019. See pages 7-8 for details

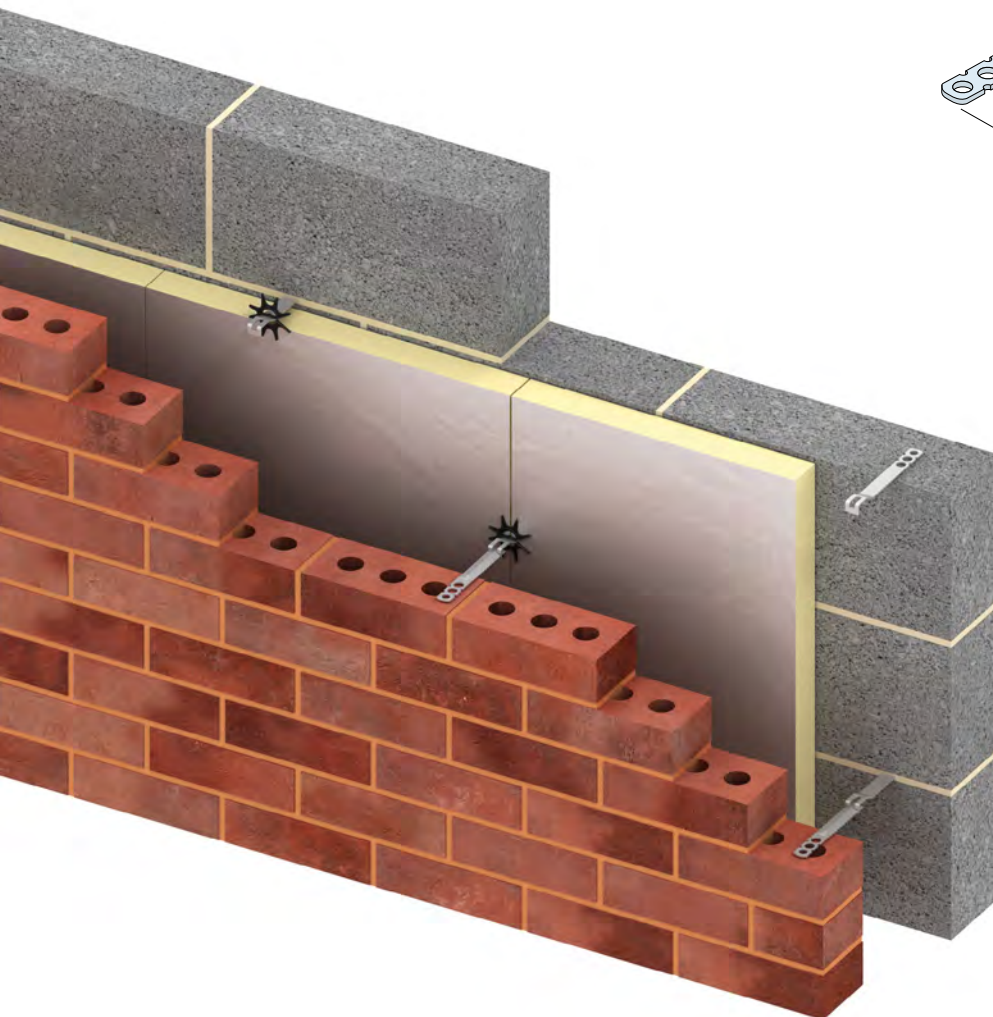
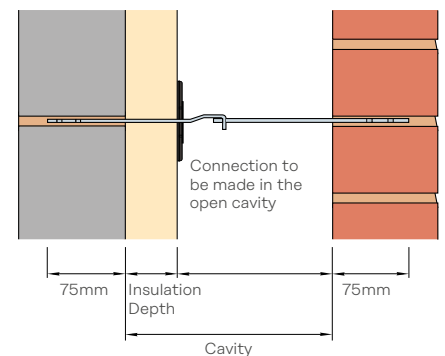
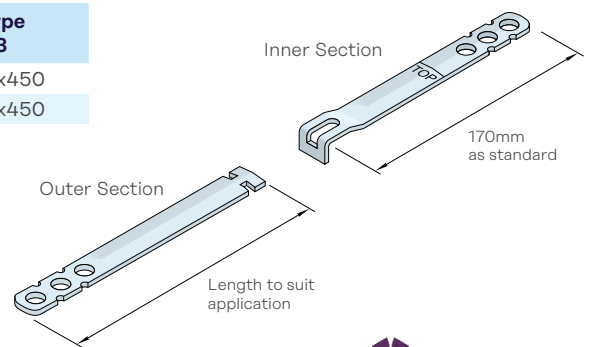

Ties for Bubble Foil Insulation

A range of ties are manufactured under license from Thermal Economics Ltd for use with Bubble Foil Insulation. These ties are available as Type 2, Type 3 and Type 4 ties to PD 6697: 2019. CB referenced ties enable the insulation material to be installed flush to the blockwork. AF referenced ties position the insulation 25mm away from the block. These ties can be used in line with NHBC standards.

Wall Tie Reference	PD 6697 Type	Length (mm)	Cavity Range (mm)
WT4-CB-185	4	185	50-60
WT4-CB-200	4	200	60-75
WT4-CB-225	4	225	85-100
WT4-CB-250	4	250	110-125
WT4-AF-200	4	200	60-75
WT4-AF-225	4	225	85-100
WT2-CB-185	2	185	50-60
WT2-CB-200	2	200	60-75
WT2-CB-225	2	225	85-100
WT2-AF-200	2	200	60-75
WT2-AF-225	2	225	85-100
WT3-AF-250	3*	250	110-125

Notes: Refer to pages 7-8 for more information on Type 4, Type 3 and Type 2 ties. *Type 2 tie at 450mm vertical x 850mm horizontal centres.

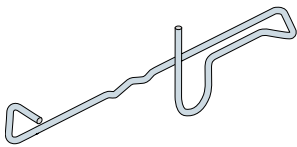

Ancon Staifix WT2-AF

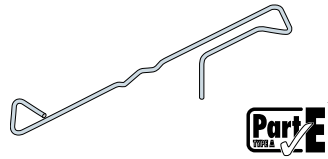

Ancon Staifix WT4-CB
*Lengths 185, 200mm

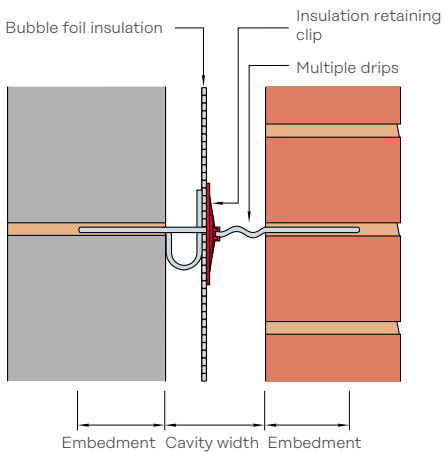

Installation of Ancon Staifix WT2-AF Wall Ties

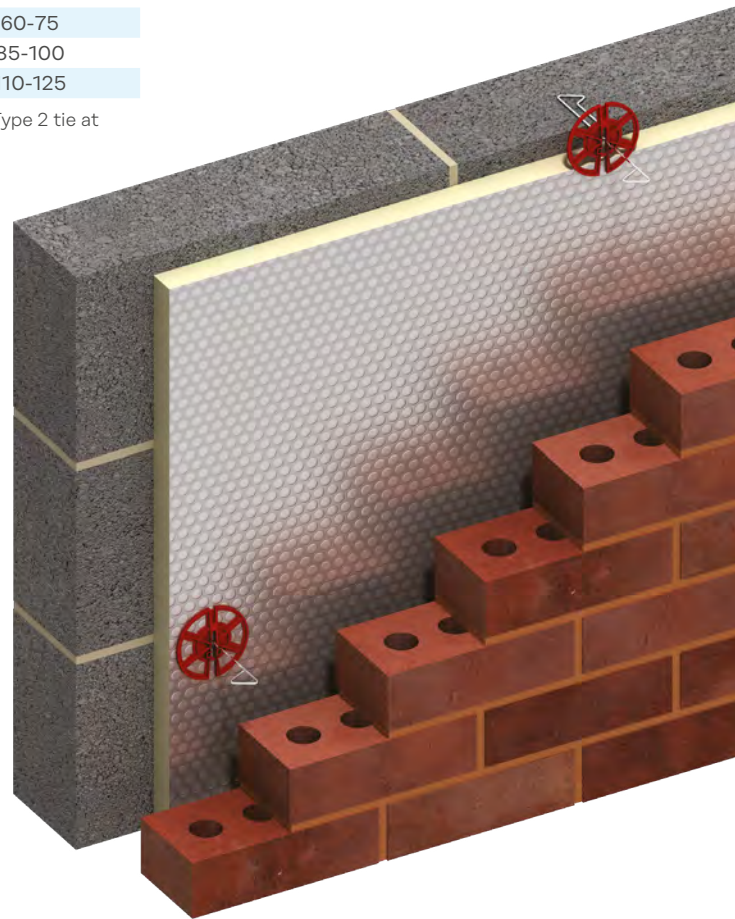

Ancon Staifix WT2-CB Wall Ties shown with Alreflex Ultratherm

Ancon Wall Ties and Restraint Fixings

Ancon 25/14 Channel fixed to Steel Framing Systems (SFS) with Ancon self-drilling high-thread screws



Ancon 25/14 Channel fixed to concrete with Ancon CFS screws, through an Ancon Compression Sleeve located in the insulation

Ancon 25/14 Restraint System

The Ancon 25/14 System is designed to tie masonry cladding to an in-situ structural frame, through a layer of insulation. It is suitable for use with steel, timber or concrete frames and any type of insulation.

The system comprises the following Ancon products: 25/14 Channel, SD25 or Teplo-BF-CT 25 Wall Ties, a choice of HTSS high thread screws (for fixing to steel/ timber) and either CFS+ or CFS screws (for fixing to concrete) and Compression Sleeves when required.

Ancon 25/14 Channel features alternate 5.3mm and 9.5mm diameter holes to accept the two fixing types. Vertical centres vary for both fixing screws and wall ties, depending on the Tie Type performance required (see pages 7-8 and table below).

We recommend that wall ties for the Ancon 25/14 System are designed to achieve a minimum embedment of 55mm in the masonry. Ancon SD25 ties are available in lengths from 100mm to 300mm to suit open cavities up to 259mm. Ancon Teplo-BF-CT 25 are available in lengths from 150mm to 375mm to suit open cavities up to 334mm.

The Ancon 25/14 System has been independently tested at Lucideon.

Fixing to Steel/Timber

Ancon self-drilling high-thread screws fix through the channel and the insulation and into the steel or timber framing system. These fixings are available for a combined backing board and insulation thickness of up to 220mm. They can be installed directly through the insulation when using any thickness of rigid insulation or when using Isover Polterm Max Plus, Kingspan Facades K-Roc Rainscreen Slab, KlasseROCK® Rainscreen Insulation, Knauf Insulation Rocksilk® RainScreen Slab, ROCKWOOL NyRock® Rainscreen 032, ROCKWOOL RainScreen Duo Slab® and Unilin Insulation Stonewool with a maximum thickness of 180mm. When using more flexible insulation materials up to 220mm thick, an Ancon Compression Sleeve is required around the fixing screws.

Fixing to Concrete

Ancon CFS+ and CFS screws fix through the channel and the insulation into a pilot hole in the concrete. Ancon Compression Sleeves (located in the insulation), are required for all CFS screws but not CFS+. Both systems are suitable for all insulation types up to a thickness of 270mm.

Ancon CFS screws are also available for fixing the channel directly back to concrete where no insulation is present - for further information please contact us.

Note: concrete strength increases with age and care should be taken when fixing Ancon 25/14 channel back to older concrete. Ancon CFS+ screws are not recommended for use with concrete grades greater than C50/60 and Ancon CFS screws are not recommended for grades greater than C35/45. For further information and additional guidance on embedment depths and torque settings, please refer to our installation guide or contact us.

Recommended Vertical Centres for Ancon Wall Ties & Fixing Screws

Tie Type	Maximum Backing Board & Insulation Thickness (mm)			Vertical Tie Spacing (mm)	Vertical Screw Spacing (mm)
	Steel	Timber	Concrete		
1				300**	225
2	220	186	270	450	337.5
3				450	337.5/450*
4				450	337.5/450*

Notes: Based on Ancon 25/14 Channel at 600mm horizontal centres. Centres shown achieve equivalent tie type performance to PD 6697: 2019, Table 12 (M2 mortar). See pages 7-8 for more details on Tie Types. *337.5mm centres for insulation thickness > 114mm. **225mm vertical tie spacing for Ancon Teplo-Channel Ties 300mm and longer.

Datasheets featuring wall tie and fixing screw references are available to help with specification. Visit www.ancon.co.uk or contact us.



Ancon CFS+ Screw

Ties for Thin-Joint Blockwork

Ancon Staifix-Thor Helical TJ2 Wall Tie

The Ancon Staifix-Thor Helical TJ2 Wall Tie hammers directly into aerated concrete blocks, through insulation material, and is built into the bed joints of the outer leaf of brickwork. It is ideal for thin-joint blockwork and other applications where the joints in the inner and outer leaves are not aligned.

This tie can be used in line with NHBC standards and meets the requirements of PD 6697: 2019 as a type 2 or 3 wall tie depending on the block used and the cavity width. The Ancon Staifix TJ2 has a cross-sectional area of 8.8mm².

The helix of the Ancon Staifix-Thor Helical range differs from other helical fixings; each rotation interlocks perfectly down its length guaranteeing maximum performance. Tools are available to simplify installation.

The black Ancon Teplo Clip is designed for use with Ancon Staifix-Thor Helical TJ2 Wall Ties.

Ancon Staifix HRT4 Wall Tie

For thin-joint to thin-joint separating walls (min. joint thickness 3mm) use the Ancon Staifix HRT4 (see page 11).

TJ2 to PD 6697:2019

Block Strength (N/mm ²)	Cavity Width (Tie Length)				
	50mm (205mm)	75mm (230mm)	100mm (255mm)	125mm (280mm)	150mm (305mm)
2.8	Type 3	Type 3	Type 3	Type 3	Type 3
3.5	Type 3	Type 3	Type 3	Type 3	Type 3
7.0	Type 2	Type 2	Type 2	Type 2	Type 2
10.0	Type 2	Type 2	Type 2	Type 2	Type 2

Note: For maximum building height and restriction based on geographical location please refer to pages 7-8.



Ancon Staifix-Thor Helical TJ2 Thin-Joint Tie
European Patent No. 1307303

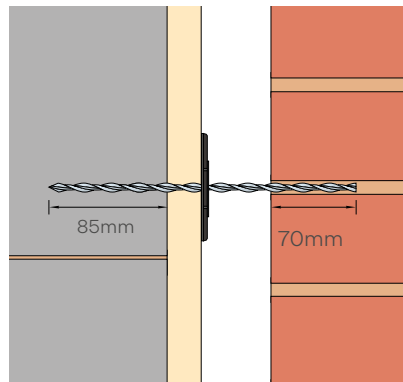

Embedment Depths

TJ2 Recommended Lengths

Cavity Width (mm)	Tie Length (mm)
50	205
75	230
100	255
125	280
150	305

Ancon Wall Ties and Restraint Fixings

Ties for Cellular Clay Blocks

We developed an innovative range of wall ties for use with cellular clay blockwork, where the horizontal bed joints are just 1mm.

The range includes cavity wall ties for use with external brickwork, cavity wall ties for internal separating walls to Approved Document E and ties for connecting perimeter walls to internal walls.

Installation of the component parts of cavity wall ties in this range are phased which eliminates any danger of injury from wall ties projecting from a part-built cavity wall.

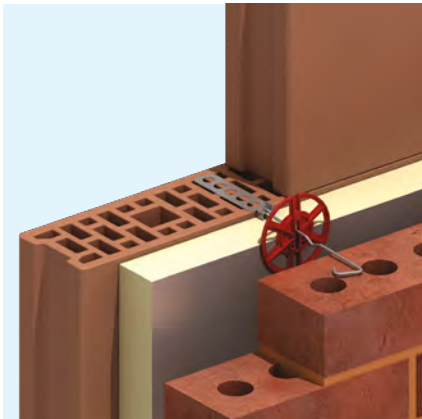

Ancon CCB4 Wall Tie



Ancon CCB-IWJ Ties for Internal Wall Junctions

Cellular Clay Block to Traditional Masonry

Product Ref.	Cavity Width (mm)	Type 4 Performance	Type 3 Performance	Type 2 Performance
		Horizontal x Vertical Spacings (mm)		
CCB4-100	100	900 x 450	600 x 450	450 x 450
CCB4-125	125	900 x 450	600 x 450	375 x 400
CCB4-150	150	900 x 450	450 x 450	-

Note: For maximum building height and restriction based on geographical location please refer to pages 7-8.

Ancon CCB –TMJ-200*
180mm

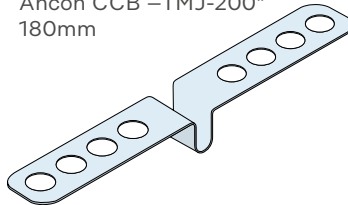

*Declared Shear Value 280N

Ancon CCB –SMJ-200*
95mm

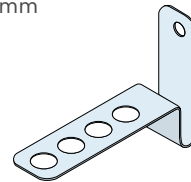

*Declared Shear Value 280N

Ancon CCB –L-200*
130mm

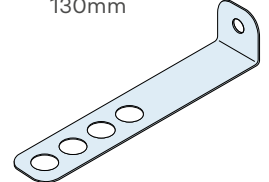

*Declared Shear Value 690N

CCB-JJ Ties (all 80mm embedment)

Product Ref.	Cavity Width (mm)	Tie Type
CCB-JJ-210	50	2
CCB-JJ-235	75	2
CCB-JJ-260	100	2
CCB-JJ-285	125	3
CCB-JJ-310	150	3
CCB-JJ-335	175	3
CCB-JJ-360	200	3

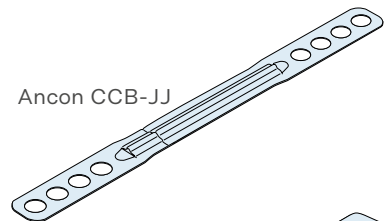

Ancon CCB-JJ

Can be used with Teplo Insulation Retaining Clip

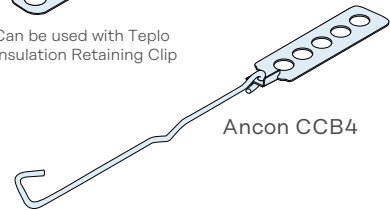

Ancon CCB4

Cellular Clay Block to Cellular Clay Block for Internal Separating (Party) Walls

Cavity Width (mm)	Product Reference	Horizontal x Vertical Spacing (mm)
75	CCBA-75	900 x 450
100	CCBA-100	900 x 450

Note: Type A tie suitable for use in internal separating walls of any height to Approved Document E: Resistance to the Passage of Sound.

Ancon CCBA-75

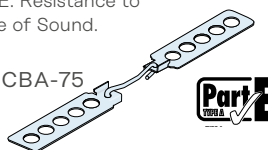

Flat Tie for connecting perimeter walls to internal walls

Product Reference	Length (mm)
CCBA-IWJ-100	180

Note: For block widths greater than 140mm, two ties should be used per course.

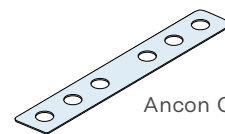

Ancon CCB-IWJ-180

Ties for Timber Frames

There is a choice of three Ancon Type 6 Timber Frame Ties designed to fix brickwork or blockwork to timber-framed structures up to 4 storeys in height and accommodate maximum differential movement of 24mm; the Type 7 Ancon TFMT Wall Tie is available for other timber frame applications.

Ancon Staifix Timber Frame Tie, STF6 (Type 6)

The Ancon Staifix STF6 tie is available in three lengths to suit 50mm, 75mm and 100mm cavities.

It is supplied complete with an annular ring shank nail. The tie is cranked to simplify correct installation and to prevent moisture from crossing the cavity. The Ancon Staifix STF6 has a cross-sectional area of 12mm² and stainless steel has a thermal conductivity of 17W/mK; this information is provided to aid U-value calculations.

The Ancon Staifix STF6 tie has been independently tested for use with 15mm OSB (Oriented Strand Board) SIPS Panel. The standard annular ring shank nail should be replaced with a 4 x 30mm stainless steel Spax® screw.

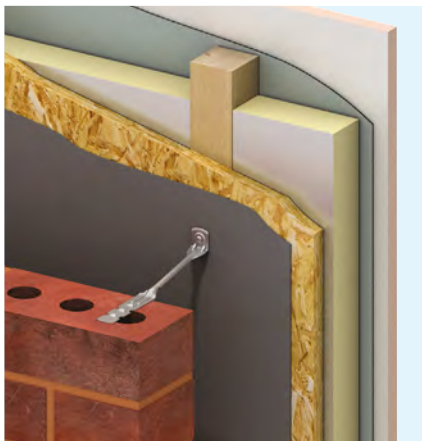

Ancon Staifix STF6 Timber Frame Tie
Available to suit 50mm, 75mm and 100mm cavities.

Ancon Staifix-Thor Helical Timber Tie, TIM6 (Type 6)

The Ancon Staifix-Thor Helical TIM6 is available in four standard lengths. It is suitable for cavities up to 150mm and can be used with the red Staifix Universal Clip where insulation is to be retained in the cavity. An installation tool is required to hammer the tie into the timber frame. The TIM6 has a cross-sectional area of 6.6mm² and stainless steel has a thermal conductivity 17W/mK; this information is provided to aid U-value calculations.

A minimum embedment depth of 30mm is required in the timber frame (this should not include the thickness of any sheathing board). At least 60mm embedment should be achieved in the masonry leaf.

Tie Length (mm)	Cavity Width* (mm)
175	0-75
200	76-100
225	101-125
250	126-150

*Based on 10mm thick sheathing board

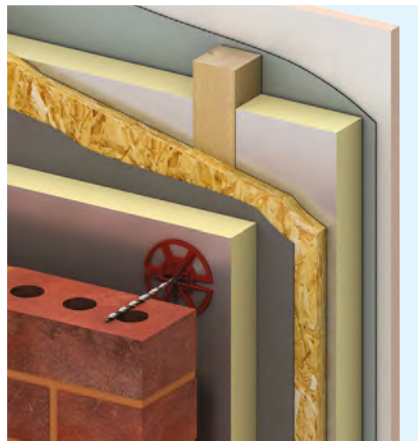

Ancon Staifix-Thor Helical TIM6 Tie

Ancon Timber Frame Movement Tie, TFMT7 (Type 7)

Where standard Type 6 Timber Frame Ties are unsuitable, our recommendation is the use of the Ancon Timber Frame Movement Tie. Manufactured to suit any cavity from 50mm to 150mm, the Ancon Timber Frame Movement Tie comprises a channel, a strip tie and a screw. This system accommodates maximum differential movement of 60mm; the tie should be positioned 15mm from the bottom of the channel. The tie is suitable for use with the Universal Insulation Clip.

The Ancon TFMT complies with BS 5268-6.1 as a Type 7 tie. See pages 7 - 8 for more information on Type 7 ties.



Ancon TFMT7 Timber Frame Movement Tie

Ancon Wall Ties and Restraint Fixings

Ancon Teplo-BFL-Tie (Type 6)

The Ancon Teplo-BFL-Tie is ideal where a low thermal conductivity restraint fixing is required between a masonry outer leaf and an in-situ timber frame. The body is manufactured from basalt fibres set in a resin matrix and features a moulded 'BF' end for building into the outer leaf. At the opposite end is a stainless steel upstand with a 7mm diameter fixing hole. When fixing to timber, we recommend a 5mm x 30mm countersunk wood screw.

This tie is suitable for cavities from 76mm to 400mm and the unique ribbed shank acts as an integral water drip, preventing water crossing the cavity. The Ancon Teplo-BFL-Tie can be used with the black Teplo-Clip where insulation is to be retained.

The Ancon Teplo-BFL-Tie has been independently tested, is approved by the BBA and can be used in line with NHBC standards.

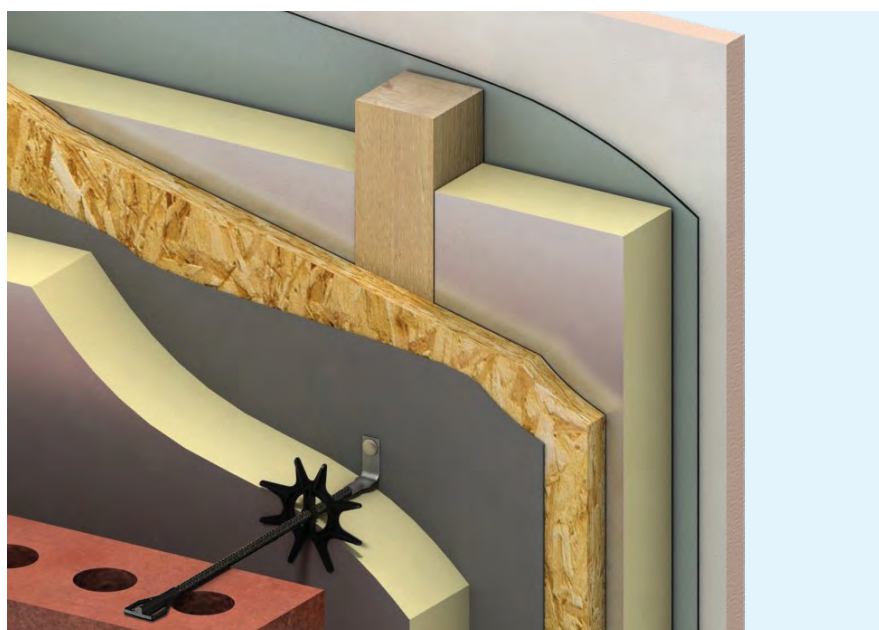

Ancon Teplo-BFL-Tie (Type 6)

A Lambda value (W/mK) is normally given for Ancon Wall Ties which expresses the thermal conductivity of the material i.e. 17W/mK for stainless steel ties and 0.7W/mK for basalt fibre Teplo ties, however, as the Ancon Teplo-BFL-Tie comprises both materials a Lambda value is not applicable. Instead, to aid with U-value calculations, the adjacent table provides the Chi value of an individual Ancon Teplo-BFL-Tie and the U-value correction (ΔU_f) if Ancon Teplo-BFL-Ties were installed at the standard 4.4 ties per square metre. BS EN ISO 6946 permits the corrections due to wall ties and air gaps between insulation boards etc., to be omitted from U-value calculations if the corrections amount to less than 3% of the uncorrected U-value of the element.

The Ancon Teplo-BFL-Tie is suitable for fixing to a range of substrates. For more information, see pages 22 and 23.

Ancon Teplo-BFL-Tie Type 6 Range and Chi Values

Product Code	Length (mm)	Cavity (mm)	BS5268 Type	Chi-value (W/K)	ΔU_f 4.4 ties/m ² (W/m ² K)
Teplo-BFL-5-155	155	76 - 100	6	0.000370	0.00163
Teplo-BFL-5-180	180	101 - 125	6	0.000300	0.00132
Teplo-BFL-5-205	205	126 - 150	6	0.000250	0.00110
Teplo-BFL-5-230	230	151 - 175	6	0.000200	0.00088
Teplo-BFL-5-255	255	176 - 200	6	0.000165	0.00073
Teplo-BFL-7-280	280	201 - 225	6	0.000225	0.00099
Teplo-BFL-7-305	305	226 - 250	6	0.000200	0.00088
Teplo-BFL-7-330	330	251 - 275	6	0.000175	0.00077
Teplo-BFL-7-355	355	276 - 300	6	0.000160	0.00070
Teplo-BFL-7-380	380	301 - 325	6	0.000145	0.00064
Teplo-BFL-7-405	405	326 - 350	6	0.000135	0.00059
Teplo-BFL-7-430	430	351 - 375	6	0.000120	0.00053
Teplo-BFL-7-455	455	376 - 400	6	0.000110	0.00048

Ancon Frame Cramps

Ancon Frame Cramps are an ideal solution where a restraint is required between masonry and in-situ structures. They can be fixed to a range of materials including concrete, steelwork and masonry. Ancon Frame Cramps referenced **_P_** have a plain shank, while those referenced **_D_** feature an integral drip for use across a cavity.

Ancon SDB

Ancon SDB Frame Cramps used as cavity wall ties exceed the requirements of a Type 2 tie to PD 6697: 2019 for lengths up to 450mm. They have a 7mm diameter hole to suit a range of fixings. Ancon M6 Expansion Bolts are recommended for fixing to concrete and M6 set screws or SDTSS-38-5PT self-drilling screws for fixing to steelwork. Frame cramps can be fixed to masonry with suitable plugs and screws or resin anchors. Poor substrates will limit the capacity of fixings and site testing is advisable in such applications. All fixings should be used in conjunction with a DIN washer.

Ancon SDV

Ancon SDV Frame Cramps have an 8mm x 30mm vertical slot that allows vertical fixing position adjustment where required. Their load capacity is limited when fixed in the top of the slot therefore they are not recommended for applications where tension is a consideration.

Isolation

Ancon Isolation Sleeves and pads are supplied blank for use with Ancon Self-Drilling Screws to isolate stainless steel frame cramps from mild steel. Self-adhesive isolation pads are also available for **_B** (20 x 30mm) and **_V** (25 x 50mm) referenced frame cramps, up to 300mm long.



Isolation Sleeve

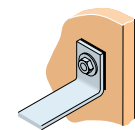

Adhesive Isolation Pad

Ancon Thermal Breaks

Ancon Frame Cramps can be supplied with Thermal Breaks to be located between the upstand and the structural frame to reduce thermal bridging across an insulated cavity. They have a thermal conductivity of just 0.3 W/mK.

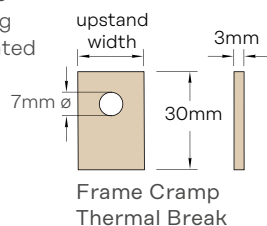

Frame Cramp Thermal Break

Recommended Tie Lengths and Fixing Centres for Ancon SDB Frame Cramps

Cavity Width (mm)	Length of Wall Tie (mm)	Recommended Spacing (mm)	
		Type 1	Type 2
45-69	125	600 x 450	900 x 450
70-94	150	600 x 450	900 x 450
95-119	175	900 x 450	900 x 450
120-144	200	900 x 450	900 x 450
145-169	225	900 x 450	900 x 450
170-194	250	900 x 450	900 x 450
195-219	275	900 x 450	900 x 450
220-244	300	900 x 450	900 x 450

Cavity Width (mm)	Length of Wall Tie (mm)	Recommended Spacing (mm)	
		SDB-T1	SDB-T2
245-269	325	900 x 450	900 x 450
270-294	350	900 x 450	900 x 450
295-319	375	900 x 450	900 x 450
320-344	400	900 x 450	900 x 450
345-369	425	900 x 450	900 x 450
370-394	450	900 x 450	900 x 450

Notes: Due to limited length of wall tie, the water drip position will be located 75mm from the embedded end. Spacing shown achieves equivalent tie type performance to PD6697:2019. See Pages 7-8 for details.

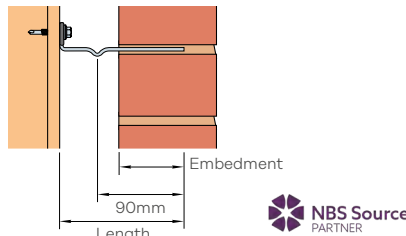

Ancon SDB Frame Cramp Fixed to Steel with Ancon Self-Drilling Screw

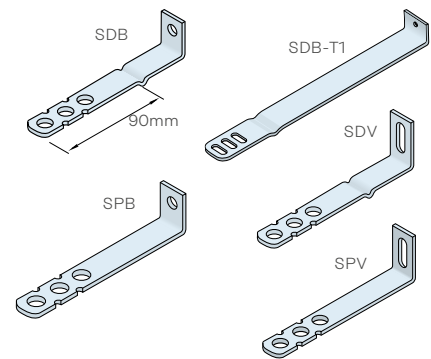

Ancon SPA

Where masonry is in line with a column flange, a notched wall tie is used in conjunction with a bespoke angle section to allow the mechanical fixing to be suitably located. This system is referenced SPA. The angle section features a 7mm fixing hole as standard and a slot to accept the wall tie. The slot provides vertical tolerance in the position of the tie allowing the angles to be fixed in advance of the masonry if required. Ties can be used with debonding sleeves when used at vertical movement joints. The thickness, size and shape of the angle are designed to suit each application. As standard the Ancon SPA is designed to suit a load of 500N (SLS) unless otherwise requested.

Contact our Technical Department or download the online design sheet.

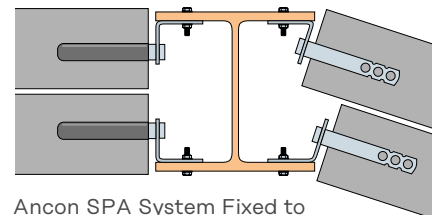
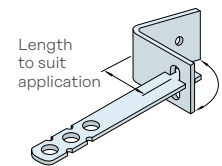

Ancon SPA System Fixed to Steel with Ancon M6 Isolated Set Screws

Pre-Fixing Aids

The practice of pre-fixing frame cramps in advance of masonry can accelerate the speed of construction and provides an opportunity to check that wall restraints have been located correctly and are securely fixed.

Ancon Gauge Tape (Pre-fix Patent 2 256 223)

Ancon Gauge Tape illustrates the standard 225mm brick/block gauge and the fixing position of frame cramps. It is applied directly to the structural frame (steel, concrete, timber or masonry) to facilitate the pre-fixing of frame cramps and to maintain accurate masonry coursing.

Ancon ISO-TW Washer

The ISO-TW washer enables Ancon Slot-ended Frame Cramps to be vertically adjusted within the 30mm range of the slot to suit the exact location of mortar joints without affecting the integrity of the fixing. In addition, this washer prevents bi-metallic corrosion by separating the frame cramp from the structural frame and fixing screw.



Ancon ISO-TW and Gauge Tape

Ancon Wall Ties and Restraint Fixings

Ancon Teplo-BFL-Tie

The Ancon Teplo-BFL-Tie is ideal where a low thermal conductivity restraint fixing is required between a masonry outer leaf and an in-situ structure. It offers the same thermal benefits as Ancon Teplo-BF Cavity Wall Ties (pages 12-13), with an additional stainless steel upstand which is mechanically fixed to one end of the tie to allow for a secondary fixing.

The 7mm diameter hole in the upstand suits a variety of fixings, typically an Ancon M6 Expansion Bolt for concrete, a plug and screw for either masonry or concrete, and either an M6 set screw or SDTSS-38-5PT self-drilling screw for steelwork. The load performance will depend on the substrate and on-site pull out tests are recommended to confirm the strength of uncertain or old substrates. For fixing to timber frames, see pages 19-20.

Ancon Teplo-BFL-Ties are suitable for cavities from 76mm to 400mm. The range comprises 18 standard products which meet the performance of Tie Types 2 or 3 when installed at a standard spacing of 2.5 ties per square metre; decreasing wall tie centres can increase the performance level as shown in the table opposite.

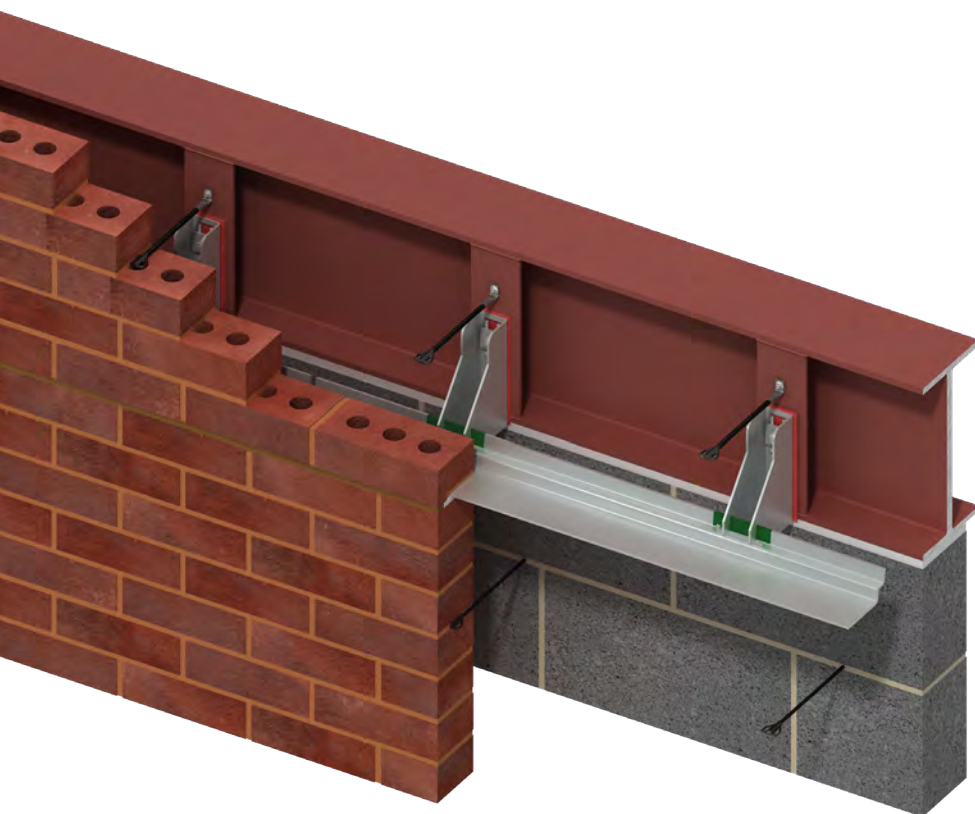

Ancon Teplo-BF Cavity Ties and Teplo-BFL-Tie Frame Cramps used with an Ancon Stainless Steel Brick Support System featuring an Ancon Thermal Break



Ancon Teplo-BFL-Ties can be fixed to concrete, masonry, steel and timber

The unique ribbed shank acts as an integral water drip, preventing water crossing the cavity. The Ancon Teplo-BFL-Tie can be used with the black Teplo-Clip where insulation is to be retained.

A Lambda value (W/mK) is normally given for Ancon Wall Ties which expresses the thermal conductivity of the material i.e. 17W/mK for stainless steel ties and 0.7W/mK for basalt fibre Teplo ties, however, as the Ancon Teplo-BFL-Tie comprises both materials a Lambda value is not applicable. Instead, to aid with U-value calculations, the table provides the Chi value of an individual Ancon Teplo-BFL-Tie and the U-value correction (ΔU_p) if Ancon Teplo-BFL-Ties were installed at the standard spacing of 2.5 ties per square metre (900mm x 450mm centres). BS EN ISO 6946 permits the corrections due to wall ties and air gaps between insulation boards etc, to be omitted from U-value calculations if the corrections amount to less than 3% of the uncorrected U-value of the element.



The BBA-approved Ancon Teplo-BFL-Tie is available to suit cavities from 76mm to 400mm



Cavity Range, Recommended Tie Spacing and Chi Values for Teplo-BFL-Ties

Product Code	PD 6697 Tie Type	Cavity range (mm)	Tie Length (mm)	Recommended Spacing mm			Chi value** (W/K)	ΔU_r 2.5 ties/m ² (W/m ² K)
				Type 1*	Type 2	Type 3		
Teplo-BFL-7-155	2	76 - 100	155	600 x 450	900 x 450	-	0.000570	0.00143
Teplo-BFL-7-180	2	101 - 125	180	600 x 450	900 x 450	-	0.000450	0.00112
Teplo-BFL-7-205	2	126 - 150	205	600 x 450	900 x 450	-	0.000360	0.00090
Teplo-BFL-7-230	2	151 - 175	230	600 x 450	900 x 450	-	0.000290	0.00073
Teplo-BFL-7-255	2	176 - 200	255	600 x 450	900 x 450	-	0.000250	0.00062
Teplo-BFL-7-280	2	201 - 225	280	600 x 450	900 x 450	-	0.000225	0.00056
Teplo-BFL-7-305	2	226 - 250	305	600 x 450	900 x 450	-	0.000200	0.00050
Teplo-BFL-7-330	2	251 - 275	330	600 x 450	900 x 450	-	0.000175	0.00044
Teplo-BFL-7-355	2	276 - 300	355	600 x 450	900 x 450	-	0.000160	0.00040
Teplo-BFL-7-380	3	301 - 325	380	375 x 450	725 x 450	900 x 450	0.000145	0.00036
Teplo-BFL-7-405	3	326 - 350	405	375 x 450	725 x 450	900 x 450	0.000135	0.00034
Teplo-BFL-7-430	3	351 - 375	430	375 x 450	725 x 450	900 x 450	0.000120	0.00030
Teplo-BFL-7-455	3	376 - 400	455	375 x 450	725 x 450	900 x 450	0.000110	0.00027
Teplo-BFL-5-155	3	76 - 100	155	475 x 450	775 x 450	900 x 450	0.000370	0.00093
Teplo-BFL-5-180	3	101 - 125	180	475 x 450	775 x 450	900 x 450	0.000300	0.00075
Teplo-BFL-5-205	3	126 - 150	205	325 x 450	650 x 450	900 x 450	0.000250	0.00063
Teplo-BFL-5-230	3	151 - 175	230	325 x 450	650 x 450	900 x 450	0.000200	0.00050
Teplo-BFL-5-255	3	176 - 200	255	325 x 450	650 x 450	900 x 450	0.000165	0.00041

Note: Centres shown achieve equivalent tie type performances to PD 6697:2019 Table 12. See pages 7-8 for details.

*Type 1 based on M2 mortar and 2500N Tensile/ 2000N Compressive capacity (PD 6697:2019)

**Based on thermal modelling using design tie embedment and mineral wool in a full fill cavity.

Ancon HiT - Hammer-in Tie

The Ancon HiT fixes masonry to dense blocks ($\geq 7N/mm^2$), non-perforated brick or hard stone. It can reduce the variety of tie lengths required on site and speed up the rate of construction.

The Ancon HiT is available in a standard length of 310mm that is bent on site with a special installation tool to suit all cavities up to 150mm. Unlike conventional frame cramps it does not require a mechanical fixing, but is hammered into a plug.

The Ancon HiT meets the requirements of PD 6697:2019 as a Type 2 tie.

A neoprene 'O' ring must be installed on the tie to prevent moisture crossing the cavity.

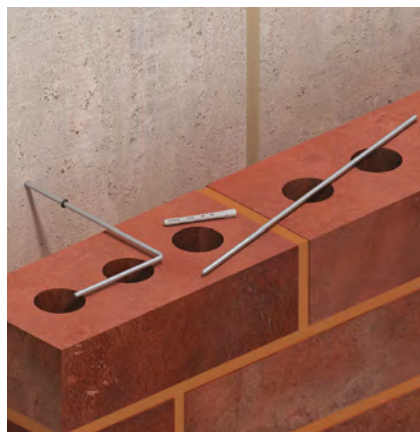

Ancon Hammer-in Tie (310mm)

Ancon Wall Ties and Restraint Fixings



Available Lengths of Ancon 21/18 Omega Channel
100, 3000mm

Ancon 21/18 Omega Channel with
 Ancon SD21 Tie



Channel Ties

Ancon 21/18 Omega Channel

Ancon 21/18 Omega Channel is a high performance, self-anchoring, cast-in channel slot suitable for use with Ancon Wall Ties to provide the necessary restraint to the outer leaf of masonry. The section is only 18mm deep and can be used where there is reduced cover to reinforcement and concrete as thin as 75mm. Available in 100mm and 3000mm lengths, Ancon 21/18 Omega Channel is filled with polystyrene to help prevent the ingress of concrete. Nail holes aid the fixing of the slot to timber formwork.

Ancon 25/14, 28/15, 30/20, 38/17, 36/8 and 40/25 Channels

Ancon Wall Ties can also be used with our Ancon 25/14, 28/15, 30/20, 38/17, 36/8 and 40/25 Channels.

The Ancon 30/20 Channel is supplied with anchors for casting into concrete. Ancon 25/14 and 36/8 Channels are supplied plain-backed for surface fixing. Ancon 28/15, 38/17 and 40/25 Channels are available with or without anchors for casting in or surface fixing. Data shown below applies to Ancon Cavity Wall Ties into Ancon 21/18, 28/15, 30/20, 38/17 and 40/25 Cast-in Channels. Ancon 36/8 Channels are only suitable for shear applications, see pages 28 and 42. For Ancon 25/14 Channels see page 16. Maximum safe working loads of surface-fixed channels will be subject to suitable fixings, and appropriate fixing centres. Consult our Technical Department for advice.

Recommended Tie Spacing for Cast-in Channel Stainless Steel Ties for Masonry Cavity Applications

Tie Length (mm)	Cavity Width (mm)	Type 1	Type 2
125	45-69	600x450	900x450
150	70-94	600x450	900x450
175	95-119	600x300	600x450
200	120-144	600x300	600x450
225	145-169	600x300	600x450
250	170-194	600x300	600x450
275	195-219	600x300	600x450
300	220-244	600x300	600x450

Note: Centres shown achieve equivalent tie type performances to PD 6697: 2019. See pages 7-8 for details.

Fixing of Channel

Fixing Method	Omega 21/18	25/14	28/15	30/20	38/17	36/8	40/25
Cast-in	✓	✗	✓	✓	✓	✗	✓
Surface Fixed	✗	✓	✓	✗	✓	✓	✓

Ancon Fastrack

Building one leaf of the cavity wall in advance of the other is often beneficial but can create problems with coursing. Buildings which incorporate imperial or continental bricks and standard metric blocks present even greater difficulties. Ancon Fastrack Channel is built into the inner leaf of blockwork ready to take an Ancon SD28 or similar tie for the outer leaf. This method of construction avoids the dangers of projecting ties.

Ancon Fastrack Channels and Ties suit cavities from 50mm to 250mm and can also be used for tying stonework to blockwork if DD28 or similar Ancon Ties are used.

The recommended tie length for use with a fastrack channel is 'cavity width plus 50mm'.

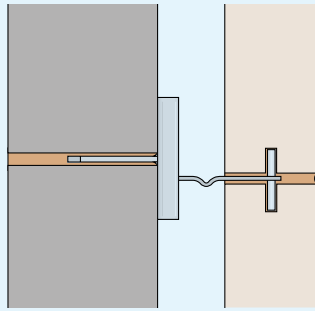

Ancon Fastrack used with Ancon DD28 Tie for Stonework

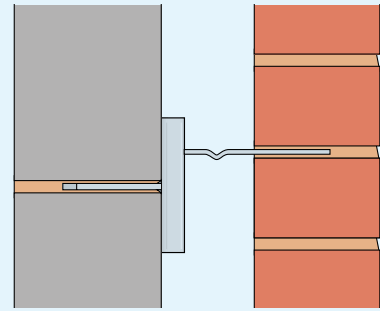

Ancon Fastrack used with Ancon SD28 Tie for Brickwork

Tie Reference	Type 1	Type 2	Type 3	Type 4
28/15 Fastrack	450x450	900x450	900x450	900x450
36/8 Fastrack	450x450	900x450	900x450	900x450

Note: Centres shown achieve equivalent tie type performances to PD 6697: 2019. See pages 7-8 for details.

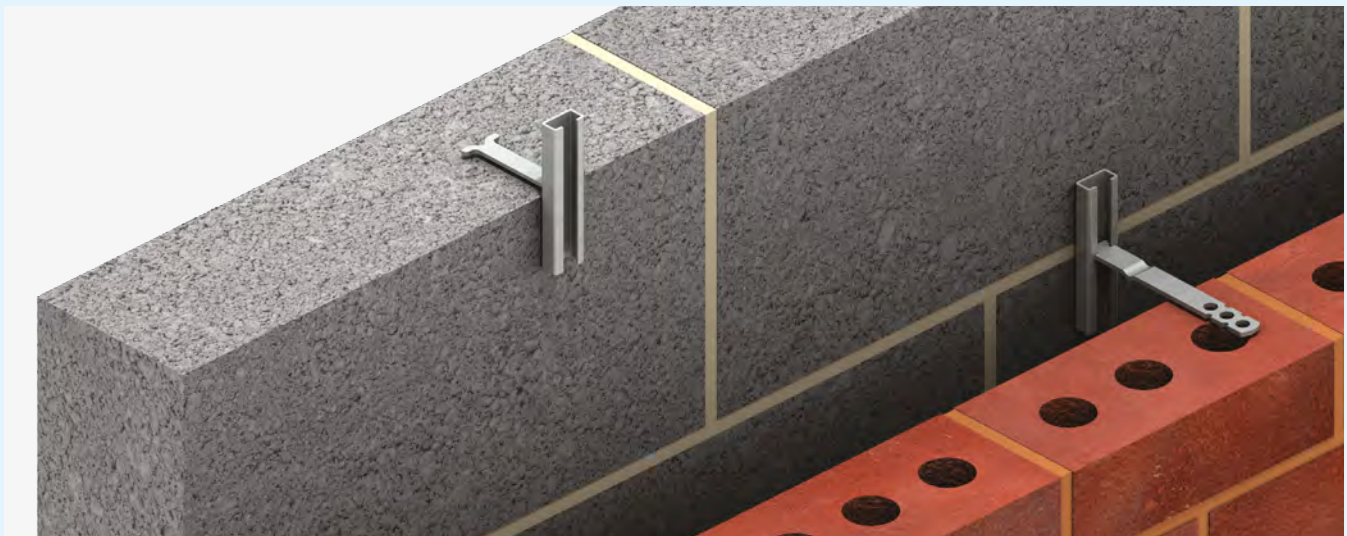

Ancon Fastrack Channels 100mm long with Ancon SD28 Tie

Ancon 28/15 Fastrack Channels and Ties sustain loads which exceed the requirements for a Type 2 tie to PD 6697: 2019. This system can also be manufactured in an Ancon 36/8 Channel which also offers Type 2 performance and accepts wall ties referenced __ 36.

Ancon Wall Ties and Restraint Fixings

Ancon Teplo-Channel Ties

The Ancon Teplo-Channel Tie range has been specifically designed to provide a low thermal conductivity wall tie for use with our popular Ancon Omega 21/18, 25/14 and 28/15 channel profiles. Ancon Teplo-Channel Ties provide unlimited adjustment along the length of the channel and are ideal for use with SFS and concrete frames.

The tie body uses the same combination of basalt fibres set in a resin matrix as the Ancon Teplo Cavity Wall Tie and has a moulded safety end for building into the outer leaf bed joint. On the opposite end is a profiled stainless steel head which is shaped to suit each individual channel and is mechanically fixed in place.

Ancon Teplo-Channel Ties are suitable for cavities from 70mm to 344mm and meet the performance of Tie Types 1, 2 or 3 depending on tie spacing; please see data table for more information. The unique ribbed shank acts as a drip and prevents water crossing the cavity. Where insulation is to be retained, the black Teplo-Clip can be used and is compatible with the full range of Ancon Teplo-Channel Ties.

A Lambda value (W/mK) is normally given for Ancon Wall Ties which expresses the thermal conductivity of the material i.e. 17W/mK for stainless steel ties and 0.7WmK for basalt fibre Ancon Teplo Ties. However, as the Ancon Teplo-Channel Ties comprise both materials, a Lambda value is not applicable. Instead, to aid with U-value calculations, the tables provide the Chi value of the individual Ancon Teplo-Channel Ties and the U-value correction (ΔU_f) if Teplo-Channel Ties were installed at a spacing of 3.7 ties per square metre (600mm x 450mm). BS EN ISO 6946 permits the corrections due to wall ties and air gaps between insulation boards etc., to be omitted from U-value calculations if the corrections amount to less than 3% of the uncorrected U-value of the element.

The Ancon Teplo-Channel Tie range has been independently tested and is BBA approved; a British Board of Agrément certificate is available to download online.



Ancon Teplo-Channel Tie Chi Values

Product Code	Tie Length (mm)	PD 6697 Tie Type	Chi value (W/K)	ΔU_f 3.7 ties/m ² (W/m ² K)
Teplo-BF-CT 21 - 150	150	2	0.0009	0.00333
Teplo-BF-CT 21 - 175	175	2	0.0006	0.00222
Teplo-BF-CT 21 - 200	200	2	0.0004	0.00148
Teplo-BF-CT 21 - 225	225	2	0.0003	0.00111
Teplo-BF-CT 21 - 250	250	2	0.0003	0.00111
Teplo-BF-CT 21 - 275	275	2	0.0002	0.00074
Teplo-BF-CT 21 - 300	300	2	0.0002	0.00074
Teplo-BF-CT 21 - 325	325	3	0.0002	0.00074
Teplo-BF-CT 21 - 350	350	3	0.0001	0.00037
Teplo-BF-CT 21 - 375	375	3	0.0001	0.00037
Teplo-BF-CT 28 - 150	150	2	0.0009	0.00333
Teplo-BF-CT 28 - 175	175	2	0.0006	0.00222
Teplo-BF-CT 28 - 200	200	2	0.0004	0.00148
Teplo-BF-CT 28 - 225	225	2	0.0003	0.00111
Teplo-BF-CT 28 - 250	250	2	0.0003	0.00111
Teplo-BF-CT 28 - 275	275	2	0.0002	0.00074
Teplo-BF-CT 28 - 300	300	2	0.0002	0.00074
Teplo-BF-CT 28 - 325	325	3	0.0002	0.00074
Teplo-BF-CT 28 - 350	350	3	0.0001	0.00037
Teplo-BF-CT 28 - 375	375	3	0.0001	0.00037
Teplo-BF-CT 28 - 400	400	3	0.0001	0.00037

Data based on thermal modelling using mineral wool in a full fill cavity with channel cast into concrete and Ancon Teplo-BF-CT Ties bridging the insulation zone.

Note: Thermal values will vary for other wall build-ups. For more information please contact Leviat.

Product Code	Tie Length (mm)	PD 6697 Tie Type	Chi value (W/K)	ΔU_f 3.7 ties/m ² (W/m ² K)
Teplo-BF-CT 25 - 150	150	2	0.0008	0.00289
Teplo-BF-CT 25 - 175	175	2	0.0007	0.00250
Teplo-BF-CT 25 - 200	200	2	0.0006	0.00216
Teplo-BF-CT 25 - 225	225	2	0.0005	0.00191
Teplo-BF-CT 25 - 250	250	2	0.0005	0.00167
Teplo-BF-CT 25 - 275	275	2	0.0004	0.00150
Teplo-BF-CT 25 - 300	300	3	0.0004	0.00133
Teplo-BF-CT 25 - 325	325	3	0.0003	0.00122
Teplo-BF-CT 25 - 350	350	3	0.0003	0.00109
Teplo-BF-CT 25 - 375	375	3	0.0003	0.00100

Data based on thermal modelling using 100mm thick mineral wool in a partial fill cavity with channel fixed to front of insulation and Ancon Teplo-BF-CT Ties bridging the remaining clear cavity.

Note: Thermal values will vary for other wall build-ups. For more information please contact Leviat.

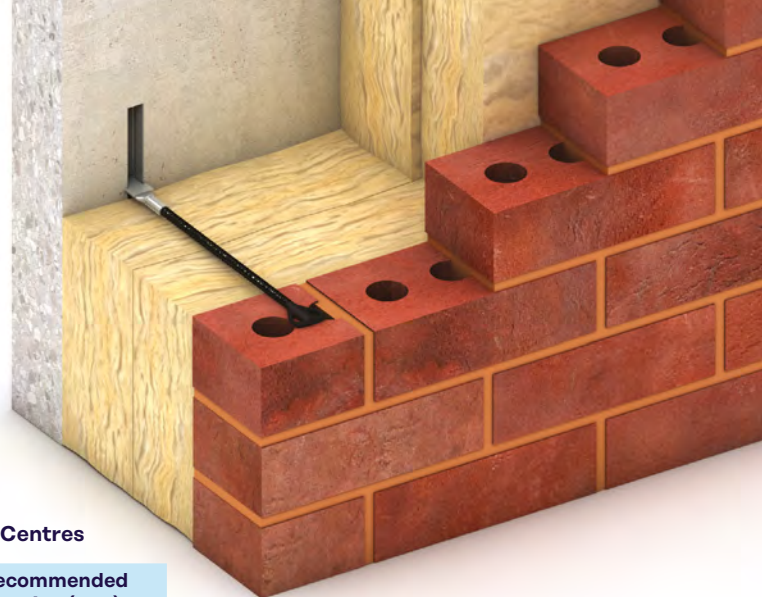

Ancon Teplo-Channel Tie Product Codes and Recommended Fixing Centres

Product Code	PD 6697 Tie Type	Cavity Range (mm)	Tie Length (mm)	Recommended Spacing (mm)	
				Type 1*	Type 2
Teplo-BF-CT 21 - 150	2	70 - 94	150	600x375	600x450
Teplo-BF-CT 21 - 175	2	95 - 119	175	600x375	600x450
Teplo-BF-CT 21 - 200	2	120 - 144	200	600x375	600x450
Teplo-BF-CT 21 - 225	2	145 - 169	225	600x375	600x450
Teplo-BF-CT 21 - 250	2	170 - 194	250	600x375	600x450
Teplo-BF-CT 21 - 275	2	195 - 219	275	600x375	600x450
Teplo-BF-CT 21 - 300	2	220 - 244	300	600x375	600x450
Teplo-BF-CT 21 - 325	3	245 - 269	325	600x225	600x450
Teplo-BF-CT 21 - 350	3	270 - 294	350	600x225	600x450
Teplo-BF-CT 21 - 375	3	295 - 319	375	600x225	600x450
Teplo-BF-CT 25 - 150	2	85 - 109	150	600x300	600x450
Teplo-BF-CT 25 - 175	2	110 - 134	175	600x300	600x450
Teplo-BF-CT 25 - 200	2	135 - 159	200	600x300	600x450
Teplo-BF-CT 25 - 225	2	160 - 184	225	600x300	600x450
Teplo-BF-CT 25 - 250	2	185 - 209	250	600x300	600x450
Teplo-BF-CT 25 - 275	2	210 - 234	275	600x300	600x450
Teplo-BF-CT 25 - 300	3	235 - 259	300	600x225	600x450
Teplo-BF-CT 25 - 325	3	260 - 284	325	600x225	600x450
Teplo-BF-CT 25 - 350	3	285 - 309	350	600x225	600x450
Teplo-BF-CT 25 - 375	3	310 - 334	375	600x225	600x450
Teplo-BF-CT 28 - 150	2	70 - 94	150	600x375	600x450
Teplo-BF-CT 28 - 175	2	95 - 119	175	600x375	600x450
Teplo-BF-CT 28 - 200	2	120 - 144	200	600x375	600x450
Teplo-BF-CT 28 - 225	2	145 - 169	225	600x375	600x450
Teplo-BF-CT 28 - 250	2	170 - 194	250	600x375	600x450
Teplo-BF-CT 28 - 275	2	195 - 219	275	600x375	600x450
Teplo-BF-CT 28 - 300	2	220 - 244	300	600x375	600x450
Teplo-BF-CT 28 - 325	3	245 - 269	325	600x225	600x450
Teplo-BF-CT 28 - 350	3	270 - 294	350	600x225	600x450
Teplo-BF-CT 28 - 375	3	295 - 319	375	600x225	600x450
Teplo-BF-CT 28 - 400	3	320 - 344	400	600x225	600x450

Note: Centres shown achieve equivalent tie type performances to PD 6697:2019 Table 12. See pages 7-8 for details.

*Type 1 based on M2 mortar and 2500N Tensile/ 2000N Compressive capacity (PD 6697:2019). Cavity range values refer to cast-in applications for 21 and 28 ends. For surface-fixed 28/15 applications, cavity values should be increased by 15mm. Cavity range values given for 25 ends refer to channels fixed to front of insulation i.e. remaining clear cavity.

Ancon Wall Ties and Restraint Fixings

Vertical Movement Joints

Debonding sleeves are used on plain-ended wall ties, such as the Ancon PP21 or PPB, at vertical movement joints that abut columns. The tie will restrain the masonry against lateral wind loads whilst the sleeve allows the masonry to expand and contract.

These shear ties are available either to suit cast-in channels or as frame cramps to be post-fixed on site. Channel ties are available to suit Ancon 21/18, 28/15, 30/20, 36/8, 38/17 and 40/25 channels. Ancon Frame Cramps are available as a PPB with a single hole or as a PPV with a vertical slot. Ancon PPS Ties are used across movement joints in masonry walls. Ancon PPB-HD is a heavy duty version of the Ancon PPB.

These ties are subject to shear rather than tensile / compressive forces and can be selected from the following table. The design resistances shown should be used with factored wind loads.

Ancon Shear Ties are suitable for a standard 10mm joint and require a minimum embedment of 100mm. Ancon Debonding Sleeves should be installed with a 10mm gap at the end to allow for expansion of the masonry. Our black injection moulded sleeves are suitable for the vast majority of our plain-ended wall ties. Larger dip-moulded sleeves are available for heavy duty ties such as the PPB-HD.

Ties are also available with a standard safety end for applications where a debonding sleeve is not required.

Design Resistances for Ancon Shear Ties

Tie	Debonding Sleeve	Design Resistance (N)	Design Resistance per metre (N/m)	
			450mm centres	225mm centres
Channel Ties	Standard	900	2000	4000
PPV	Standard	463	1028	2056
PPB	Standard	663	1474	2948
PPB-HD	Dip-moulded	896	1991	3982
PPS	Standard	896	1991	3982

Note: Design resistances shown use a material factor, γ_m , of 3.0 as given in the UK National Annex to BS EN 1996-1-1:2005

Ancon PPS Wall Tie with Debonding Sleeve
 150, 175, 200, 225, 250, 275, 300mm

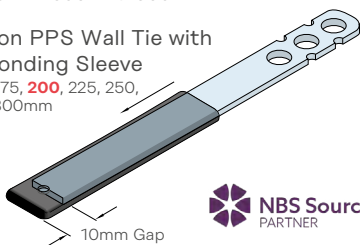

Debonding sleeves should be pulled back 10mm to allow expansion as well as contraction of brickwork

Ancon PPB Wall Tie with Debonding Sleeve
 Lengths 125, 150, 175, 200, 225mm



Ancon PPV Wall Tie with Debonding Sleeve
 Lengths 125, 150, 175, 200, 225mm



Ancon ST1 wall tie

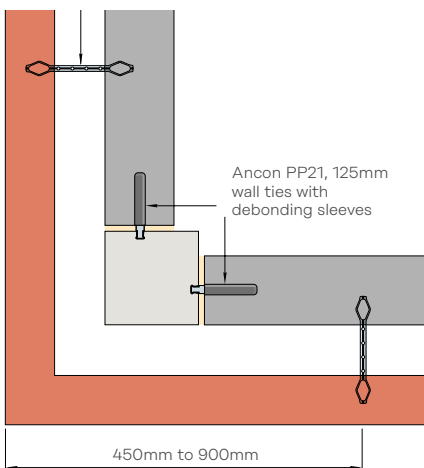

External Corner with Fully Bonded Brickwork

Note: All spacings are maximums. The type of cavity wall tie and spacing will be determined by the cavity width, height of brickwork, wind loading and type of building. See pages 7-8 for further information.

Ancon PP21, 125mm wall ties with debonding sleeves

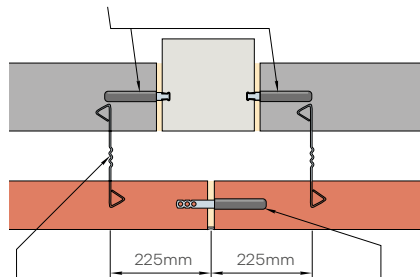

Ancon Staifix RT2 wall ties at 450mm vertical centres in alternate courses to PPS ties

Ancon PPS, 225mm wall ties with debonding sleeves, at 450mm vertical centres

Intermediate Column with Vertical Movement Joints in both Brickwork and Blockwork

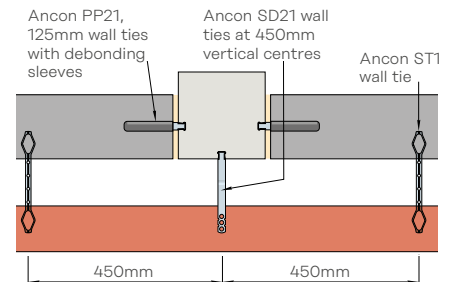

Intermediate Column with Vertical Movement Joints in Blockwork

Ancon PPS, 225mm wall ties with debonding sleeves, at 450mm vertical centres

Ancon ST1 wall tie at 450mm vertical centres in alternate courses to PPS ties

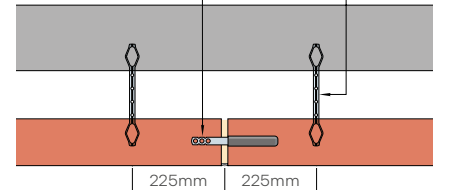

Cavity Wall with Vertical Movement Joint in Brickwork

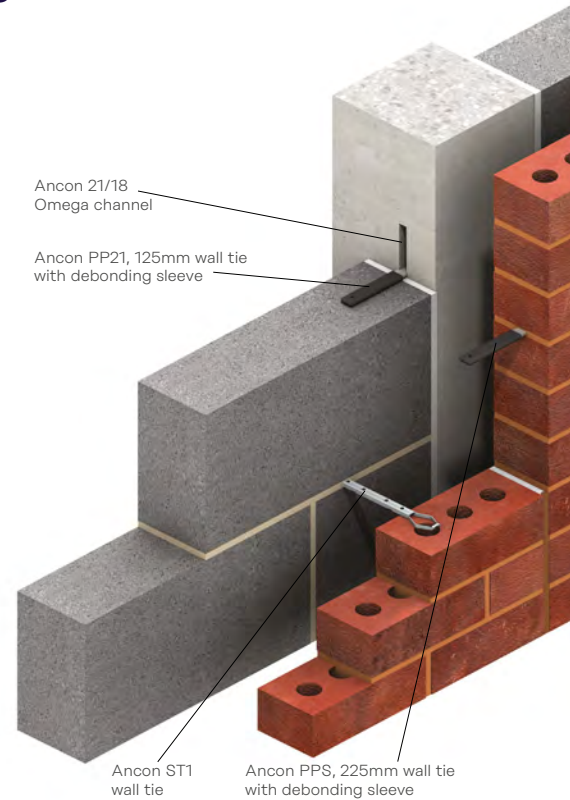

Intermediate Column with Vertical Movement Joint in Brickwork and Blockwork

Standard Wall Ties

Lengths shown in **red bold** refer to items normally available at all times.

Our Technical Services Team will be pleased to advise on the correct selection and use of our wall ties.

Ancon SDS

Lengths 200, 225, 250, 275, 300mm
Conforms to PD 6697: 2019 as a Type 1 tie in M2 (iv) mortar.
Also available with a central drip

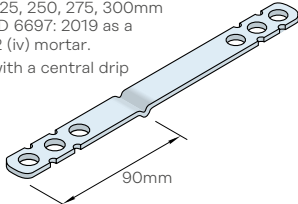

Ancon SPS*

Lengths **150, 200**, 225, 250, 275, 300mm
(Not suitable for collar-jointed construction. (See SPS C.J))



Ancon PPS*

Lengths **150, 175, 200**, 225, 250, 275, 300mm

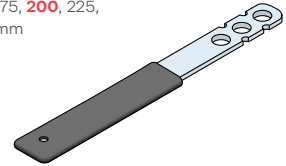

Ancon ST1

Lengths **200, 225, 250, 275, 300, 325, 350**mm
Conforms to PD 6697: 2019 as a Type 1 tie in M2 mortar

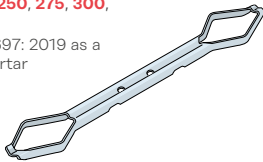

Ancon Staifix RT2

Lengths **200, 225, 250, 275**mm
Conforms to PD 6697: 2019 as a Type 2 tie



Ancon DT (Double Triangle)

Lengths **150†, 200†, 225†, 250††, 275††, 300††**mm
†Conforms to PD 6697: 2019 as a Type 2 tie
††Conforms to PD 6697: 2019 as a Type 3 tie



Ancon RD3

Lengths **250, 275**mm
Conforms to PD 6697: 2019 as a Type 3 tie

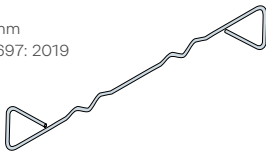

Ancon Staifix HRT4

Lengths **200, 225, 250, 275, 300**mm
Conforms to PD 6697: 2019 as a Type 4 tie



Ancon HRD4

Lengths **250, 275**mm
Conforms to PD 6697: 2019 as a Type 4 tie

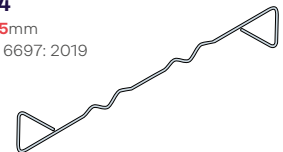

Suitable for party walls with 50-175mm cavities

Ancon Teplo-BF1

Lengths **200, 225, 250, 275**mm
Conforms to PD 6697: 2019 as a Type 1 tie.



Ancon Teplo-BF2

Lengths **200, 225, 250, 275, 300, 325, 350, 375, 400, 425**mm
Conforms to PD 6697: 2019 as a Type 2 tie



Ancon Teplo-BF4

Lengths **200, 225, 250, 550, 575**mm
Conforms to PD 6697: 2019 as a Type 4 tie



Ancon SDS-T1, SDS-T2

Lengths 325, 350, 375, 400, 425, 450, 475, 500, 525mm
Conforms to PD 6697: 2019 as a Type 1 tie in M2 (iv) mortar.
Also available with a central drip

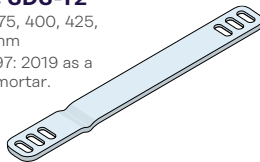

Ancon SPS CJ*

Length **150**mm
(3mm thickness for collar-jointed construction)

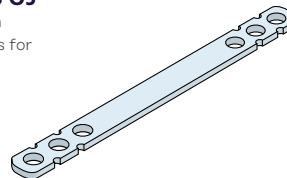

WHX

Lengths 150, 175, 200mm

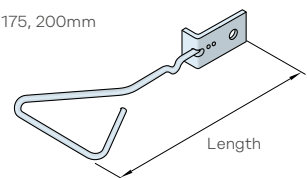

Note: *Ties with a 'P' shank are not suitable for cavity wall construction and are typically used for shear applications only. For more information please contact our Technical team.

Recommended Lengths for Masonry/Masonry Wall Ties

Cavity Width (mm)	Tie Length (mm)	Cavity Width (mm)	Tie Length (mm)
50-75	200	251-275	400
76-100	225	276-300	425
101-125	250	301-325	450
126-150	275	326-350	475
151-175	300	351-375	500
176-200	325	376-400	525
201-225	350	401-425	550
226-250	375	426-450	575

Ancon Wall Ties and Restraint Fixings

Standard Wall Ties

Lengths shown in **red bold** refer to items normally available at all times.

Our Technical Services Team will be pleased to advise on the correct selection and use of our wall ties.

Ancon SDB

Lengths ***100, 125, 150, 175, 200, 225, 250, 275, 300,** 325, 350, 375, 400, 425, 450mm

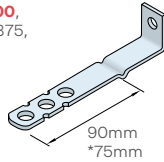

Ancon SPB*

Lengths **75, 100, 125, 150, 175, 200,** 225, 250, 275, 300mm (Heavy duty version also available)

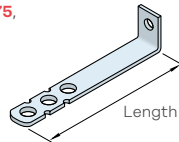

Ancon PPB*

Lengths **125, 150, 175, 200,** 225mm

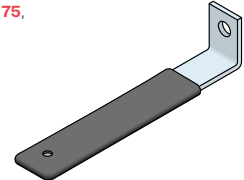

Ancon SDV

Lengths ***100, 125, 150, 175, 200,** 225, 250, 275, 300mm

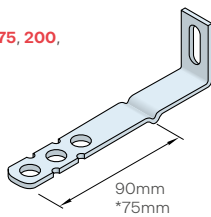

Ancon SPV*

Lengths **75, 100, 125, 150, 175, 200,** 225, 250, 275, 300mm

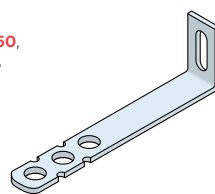

Ancon PPV*

Lengths **125, 150, 175, 200,** 225mm

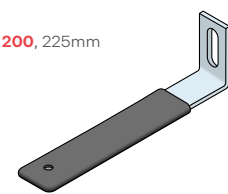

Ancon SD21

Lengths 125, 150, 175, 200, 225, 250, 275, 300mm
For use with 21/18 Omega Channel

See Channels, Bolts and Fixings brochure for more information

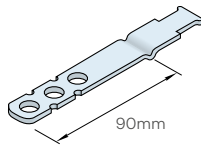

Ancon SP21*

Lengths 75, **100, 125, 150,** 175, 200mm
For use with 21/18 Omega Channel

See Channels, Bolts and Fixings brochure for more information

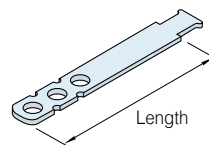

Ancon PP21*

Lengths **125, 150,** 175, 200, 225mm
For use with 21/18 Omega Channel
See Channels, Bolts and Fixings brochure for more information

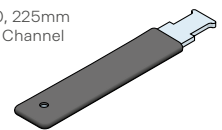

Ancon SD25

Lengths 75, **100, 125, 150, 175, 200,** 225, 250, 275, 300mm
For use with Ancon 25/14 Channel
See Ancon 25/14 Restraint System brochure for more information

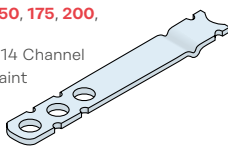

Ancon SRB

Lengths 125, 150, 175, 200, 300mm
(Used in applications instead of the SDB where greater flexibility is required)

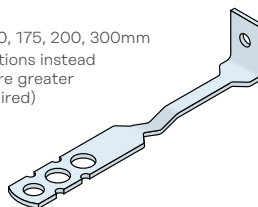

Ancon SHX

Lengths 150, 175, 200, 225mm

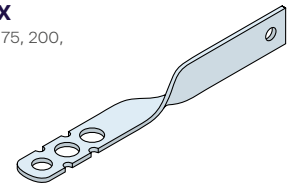

Ancon SDB-T1, SDB-T2

Lengths 325, 350, 375, 400, 425, 450mm

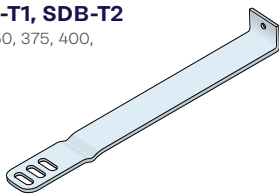

Ancon Teplo-BFL-Tie

Lengths 155, 180, 205, 230, 255, 280, 305, 330, 355, 380, 405, 430, 455mm
(See page 20 and 22)



Ancon Teplo-BF-CT

21 and 25 ends: Lengths 150, 175, 200, 225, 250, 275, 300, 325, 350, 375mm
28 ends: Lengths 150, 175, 200, 225, 250, 275, 300, 325, 350, 375, 400mm

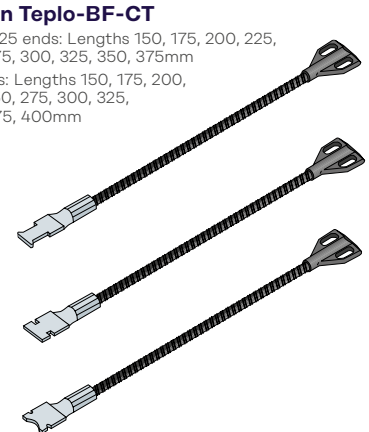

Ancon Cavity Starter Tie

Supplied with an 8mm nylon wall plug and neoprene ring
Lengths **180, 200, 230**mm

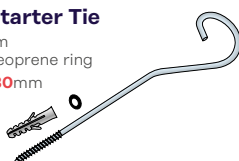

Ancon Starter Tie

Supplied with an 8mm nylon wall plug
Length **135**mm

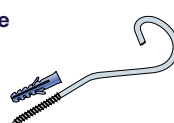

Ancon Frame Tie

Length **115**mm



Note: *Ties with a 'P' shank are not suitable for cavity wall construction and are typically used for shear applications only. For more information please contact our Technical team.

For recommended lengths, please refer to page 21 for Ancon Frame Cramps and page 24 for channel ties.

Bespoke Wall Tie References

Many variations are available in addition to the standard ties. Wall ties for special applications may be specified and ordered with ease by using a reference letter for the tail, shank and head of the tie.

These bespoke ties are manufactured to order, typically for use on a single unique project and therefore are not tested to EN 846 and do not carry UKCA or CE marking.

Ancon Ties are produced in lengths from 150mm for masonry-to-masonry ties, and 75mm for masonry-to-concrete ties, in increments of 25mm. Drips will usually be positioned 90mm from the outer end of the tie (first reference letter). Masonry-to-masonry ties can also be supplied with a central drip. Special wall ties with a section wider than 20mm referenced S_--, will have an end with three holes without the side notches.

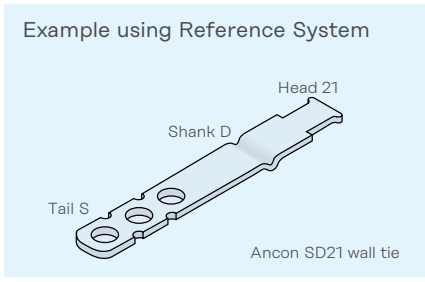

TAIL

Most can be used at either end of tie

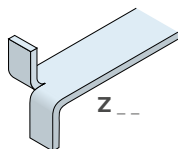
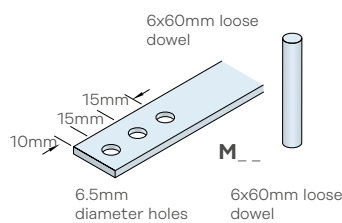
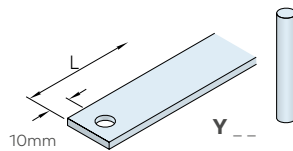
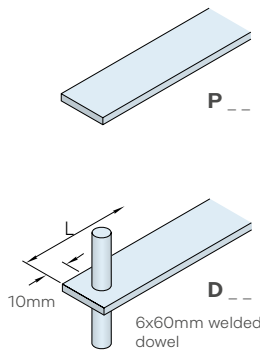
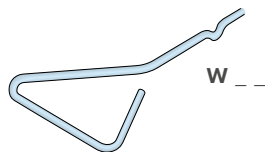
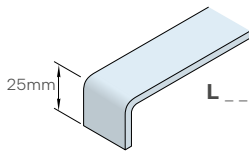
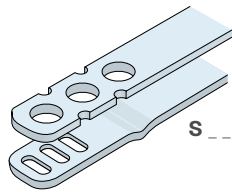

SHANK

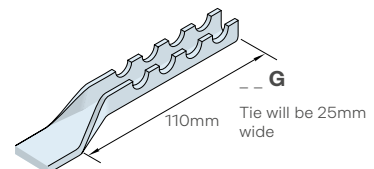
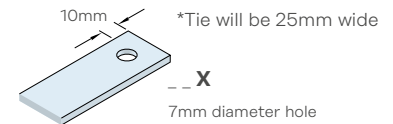
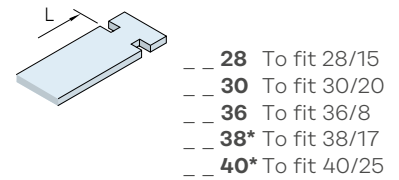
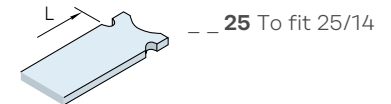
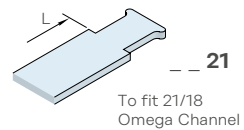
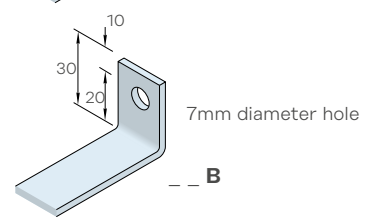
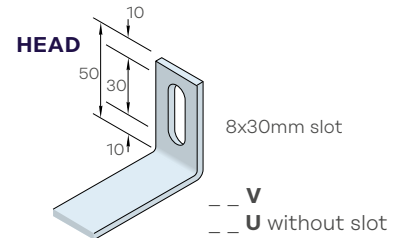
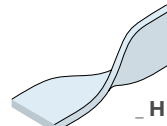
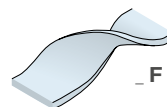
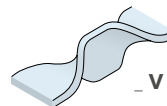
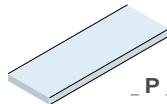
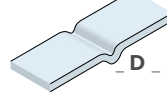

Ancon Wall Ties and Restraint Fixings

Non-combustible Insulation Retaining Clips

Product Features

- Made from stainless spring steel - rated 'A1' for reaction to fire
- Excellent corrosion resistance
- 60 year design life
- Delivered to site pre-formed and ready for installation
- Quick and simple installation
- Rounded edges for safety
- Suitable for use with all insulation types

Technical Data

	A1-ST1	A1-S*
Material	Grade 1.4310 austenitic spring steel	
Thickness	0.5mm	
Clip dimensions	80 x 65mm	
Reaction to fire (EN 13501-1)	A1	
Design life	60 years (under normal service conditions)	
Pack size / weight	250No. (5kg)	
Suitable for use with	Ancon ST1 wall tie	Ancon flat wall ties e.g. SDB, SD21, YDB

*This clip may not be used with welded dowels ("D" end, e.g. DDB) or lipped ends ("L" or "Z" ends, e.g. LDB or ZDB).

A1-ST1 Clip

The Ancon A1-ST1 is a stainless steel insulation retaining clip specifically designed to fit the Ancon ST1 heavy duty wall tie. Made from high tensile strength spring steel, the Ancon A1-ST1 clip is fully formed and ready for use straight out of the box, simplifying and speeding up installation on site.



[Click here to watch our installation video](#)

A1-ST1 Clip Installation

Installation of the Ancon A1-ST1 clip is quick and simple:

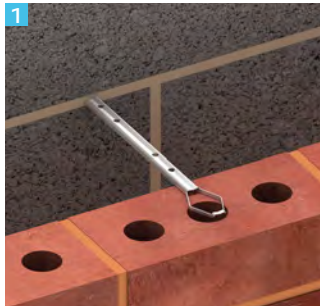

1 Build Ancon ST1 wall ties in following standard procedure (refer to our Cavity Wall Tie installation guide for full details).



2 Install insulation around wall ties.

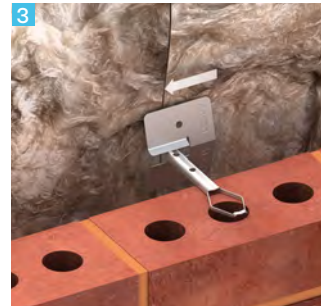

3 Fit Ancon A1-ST1 clip to each Ancon ST1 wall tie by sliding partway onto the tie.

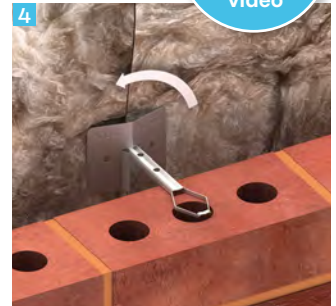

4 Rotate the clip into place on the tie shank and slide it back to contact the insulation.

A1-S Clip

The Ancon A1-S is a stainless steel insulation retaining clip specifically designed to fit a range of Ancon flat wall ties such as SDB, SD21 and YDB. Made from high tensile strength spring steel, the Ancon A1-S clip is fully formed and ready for use straight out of the box, simplifying and speeding up installation on site.



Click here to watch our installation video

A1-S Clip Installation

Example Installation of the Ancon SDB Frame Cramp:

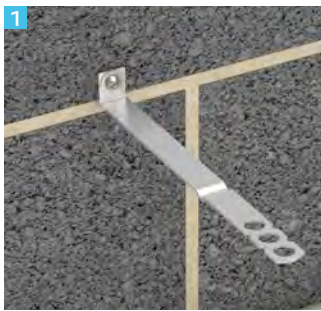

1 Install the Ancon SDB Frame Cramp according to the latest installation guide.



2 Install insulation around the frame cramp.



3 Fit Ancon A1-S clip to each SDB Frame Cramp by simply sliding onto the tie, to contact the insulation.



Note: Installation procedure is shown with the Ancon SDB frame cramp. Installation procedure is similar on all Ancon flat ties. For ties with loose dowels ("Y" or "M" ends e.g. YDB or MDB) the clip must be placed on the tie prior to the dowel being inserted.

Insulation Retaining Clips

The black Teplo Insulation Retaining Clip should be used with the Ancon Teplo range, Two-part ties, CCB-JJ tie and TJ2 ties. All other ties should be used with the red Ancon Staifix Universal Insulation Retaining Clip (Eco Clip).

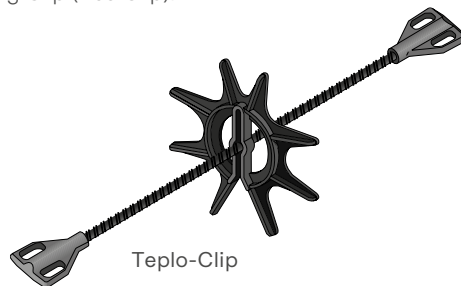
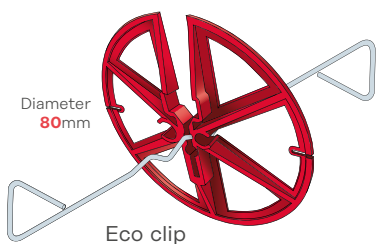

Debonding Sleeves

Debonded Ties require 100mm embedment. A 120mm long sleeve will provide an allowance for movement and tolerance, and will be suitable for most applications. Standard black injection moulded debonding sleeves accommodate the vast majority of our strip tie range. Larger dip-moulded sleeves are suitable for our heavy duty ties, such as the PPB-HD. Other sleeve lengths and sizes available to special order.

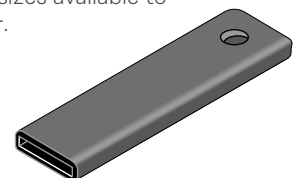

Stainless Insulation Retainer

The DHM Stainless Insulation Retainer is for securing fire-resistant soft or pressure-resistant insulating materials to concrete, blockwork and brickwork. The DHM has Fire Resistance Classification R120 and guarantees a secure fixing of fire resistant insulation.



Ancon Wall Ties and Restraint Fixings

Non-Drill Fixings for Steelwork

The Ancon range of 'non-drill' masonry-to-steel fixing solutions was developed to address the safety concerns of the Industry.

Driven by customer demand for masonry restraint fixings with an alternate installation method from either shot-firing or drilling, our company engineered the innovative solutions detailed here. These fixings do not require the use of power tools and can reduce installation times and costs. In all instances they simply abut the column or attach to the flange to restrain the wall against lateral wind loads.



Ancon Hammer-On Tie

Design Sheets

Contact us on +44 (0) 114 275 5224 or visit www.ancon.co.uk for a Non-Drill Fixings Design Sheet. This sheet summarises all the information we require to specify/quote for the most appropriate non-drill fixing to suit your application.

Ancon Non-Drill Fixings:

- Eliminate the dangers associated with shot-firing and drilling
- Quick, simple and economical to install
- No power tools required
- No special skills or equipment required
- Fixings either abut the column or attach to the flange

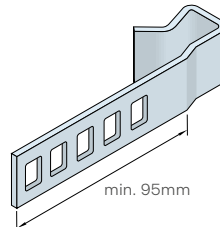

Hammer-On Section
Lengths 95mm, 155mm, 215mm

Hammer-On Section

Available in five sizes to accommodate a steel thickness from 6.8mm to 25mm, this fixing is simply hammered onto the flange. It can be utilised either on a column with a tie (HOS-TIE) or on a beam with an internal head restraint (IHR-H).

Hammer-On Section Size	Flange Thickness Accommodated
XS	6.8-10mm
S	10-13mm
M	14-17mm
L	18-21mm
XL	22-25mm

The wall tie (HOS-TIE) or head restraint (IHR-H) should be positioned central to the masonry leaf when located in one of the five fixing slots. The Hammer-On section is available in three lengths. Ancon Hammer-On Ties should be installed at 225mm vertical centres and Ancon Hammer-On Head Restraints at 450mm horizontal centres. For more information on the IHR-H Head Restraint see page 36-37.

The Hammer-On Section resists load in one direction only and should be installed on alternate sides of the flange.

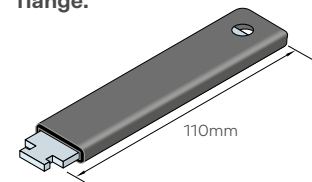

Ancon Hammer-On Tie (Debonded HOS-TIE, pictured above, supplied complete with Hammer-On Section)

Ancon Hammer-On Ties used at 225mm centres provide a design resistance of 1993N per metre.

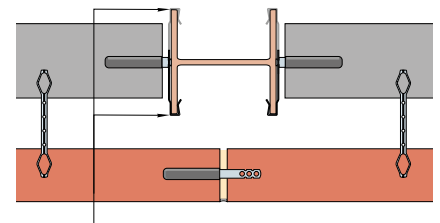

Ancon Hammer-On Ties installed to alternate sides of the column at 225mm vertical centres

Ancon Internal Column Tie

Available in seven lengths, this tie fits between the flanges of a column. It should be installed at 225mm vertical centres, providing a design resistance of 6355N per metre.

Length (mm)	Beam/Column Accommodated
179	203 x 203 UC
186	203 x 133 UB
224	254 x 254 UC
232	254 x 146 UB
275	305 x 305 UC
281	305 x 127 & 165 UB
330	356 x 127 & 171 UB

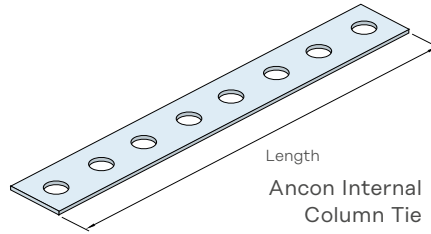

Length
Ancon Internal Column Tie

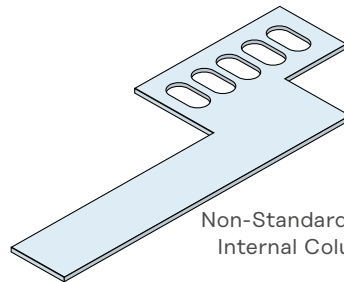
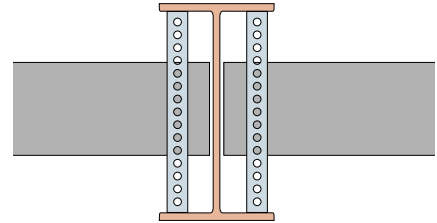

Non-Standard Ancon Internal Column Tie

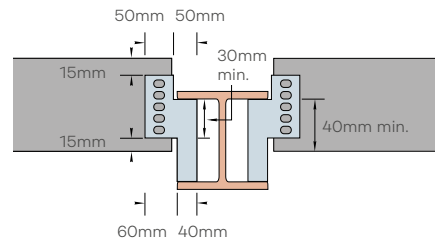

Non-Standard Ancon Internal Column Tie

Special Ancon Internal Column Ties can be designed to suit applications where the masonry does not sit inside the flanges of a column. The drawing provides some guidance on dimensions; contact us for more information.

Ancon Briclok

The Ancon Briclok fits to a column flange and can be used either across a cavity or back into the inner leaf. It should be positioned with the appropriate notch around the flange and installed at 225mm vertical centres. The tie must not be forced onto the column and should have no less than 10mm engagement. Two types (A and B) accommodate a steel thickness from 6.8mm to 20mm and are available in two lengths to suit an open cavity from 20mm to 80mm.

Ancon Briclok Ties exceed the requirements for a Type 1 tie to PD 6697: 2019 in type M2 (iv) mortar.

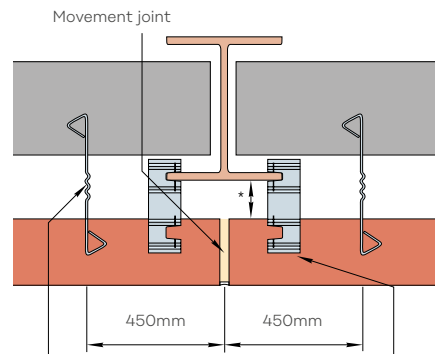
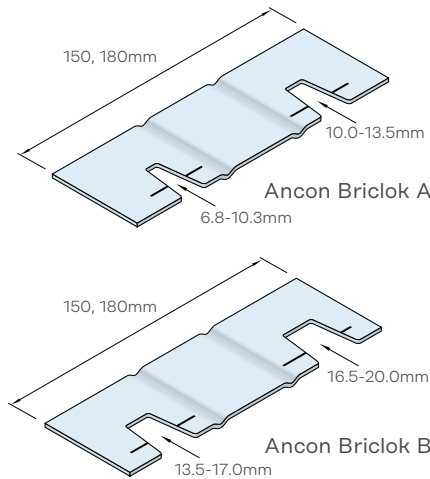

Ancon Staifix RT2 Wall Ties at 450mm vertical centres
Ancon Briclok at 225mm vertical centres. Can be used in either leaf

Ancon Column Tie

The Ancon Column Tie clamps to the flange of a column. It accommodates a steel thickness from 6mm to 25mm and should be installed at 225mm vertical centres. Manufactured in lengths to suit the application, it can feature a drip for use across the cavity or a plain shank for installation back into the inner leaf.

The clamp-on Ancon Column Tie is supplied right-handed as standard and can be manufactured left-handed on request.

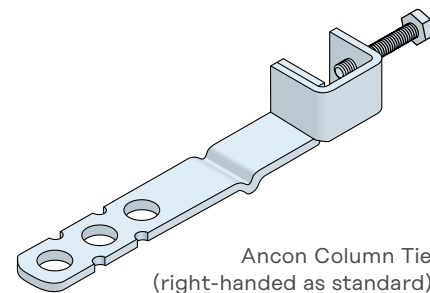

Ancon Column Tie (right-handed as standard)

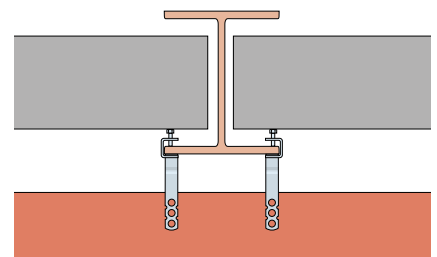

Product Code	Length	Open Cavity*	Flange Thickness
Briclok150A	150mm	20-50mm	6.8-13.5mm
Briclok180A	180mm	50-80mm	6.8-13.5mm
Briclok150B	150mm	20-50mm	13.5-20.0mm
Briclok180B	180mm	50-80mm	13.5-20.0mm

* Open cavity at column face.

Avoiding Bi-Metallic Corrosion

Bi-metallic corrosion may occur in a damp environment where stainless steel fixings are in contact with a structural steel frame. This will not affect the stainless steel but may cause slight surface corrosion to the mild steel. Best practice is to isolate the two dissimilar metals. Bitumen paint or some other form of isolation e.g. adhesive tape, applied at the point of contact will prevent this corrosion.

Ancon Wall Ties and Restraint Fixings

Ancon Head Restraints

Ancon Head Restraints provide the necessary restraint to the top of masonry walls. They allow for vertical movement to accommodate shrinkage or thermal movement of the wall or structural frame, while restraining lateral loads.

Where head restraints are to be connected to a concrete frame, we will provide fixings suitable for cracked concrete.

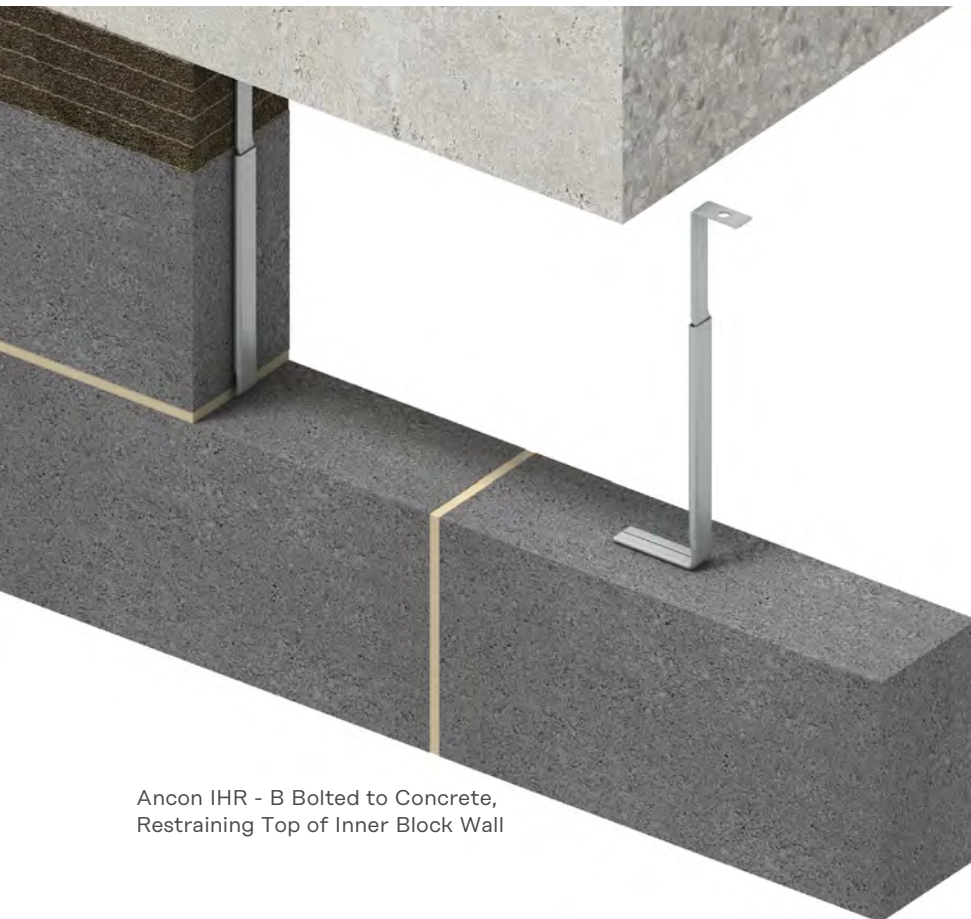

Ancon IHR - B Bolted to Concrete, Restraining Top of Inner Block Wall

Ancon IHR - Internal Head Restraint

The Ancon IHR is designed to restrain the top of internal walls or the top of the inner leaf of a cavity wall. It comprises an L-shaped channel stem and a top section available in a variety of designs to suit different fixing methods and substrates; the top section slides in the channel to accommodate vertical movement between the blockwork and the structure.

An Ancon IHR comprises a sliding top section and a stem. The standard length of an Ancon IHR sliding top section will accommodate a gap of up to 50mm. Longer top sections are available to accommodate gaps of up to 100mm, ideal when a fire stop is being incorporated at the wall head or where greater deflection is expected in the floor.

The channel stem is closed at the front to prevent mortar ingress. The base of the stem should be built into the bed joint with the centre of the stem no closer than 50mm from the edge of the block. The vertical joint should be filled with mortar each side of the stem.

The standard height of an Ancon IHR will suit a 215mm block. Other stem lengths are available to suit cut blocks with a minimum height of 140mm.

The tables provide the design resistance per metre for the Ancon IHRs when installed with a 25mm, 50mm, 75 and 100mm gap, at 900mm and 450mm centres, in full and cut blocks.

The sliding tie can be provided with either a hole (IHR - B) or slot (IHR - V) to suit M8 bolts, with a notch end to fix directly into a 38/17 or 30/20 cast-in channel (IHR - C) and with a notch end to suit the Hammer-On Section (page 34) that attaches to a 6.8mm - 25mm steel flange without site drilling (IHR - H). It is also available to suit the SDTSS-38-5PT self-tapping screw (IHR-S).



Ancon IHR-H Hammer-On Head Restraint

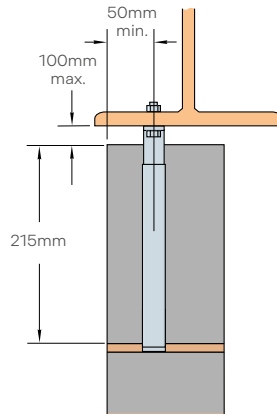

Example IHR Specification
(Delete/Amend as appropriate)

Ancon IHR-B / IHR-V / IHR-S / IHR-H / IHR-C30 / IHR-C38 internal head restraint to suit a 215mm block and a 25-50 / 51-75 / 76-100mm gap.

Design Resistances - Full Block (215mm)

Product Reference	Spacing	Design Resistances			
		25mm Gap	50mm Gap	75mm Gap	100mm Gap
IHR-B, IHR-V, IHR-C and IHR-S	900mm	1.78kN/m	1.22kN/m	1.06kN/m	1.06kN/m
	450mm	3.56kN/m	2.44kN/m	2.11kN/m	2.11kN/m
IHR-H	900mm	0.57kN/m	0.57kN/m	0.53kN/m	0.53kN/m
	450mm	1.13kN/m	1.13kN/m	1.06kN/m	1.06kN/m

Design Resistances - Cut Blocks (min. 140mm)

Product Reference	Spacing	Design Resistances			
		25mm Gap	50mm Gap	75mm Gap	100mm Gap
IHR-B, IHR-V, IHR-C and IHR-S	900mm	1.39kN/m	0.96kN/m	0.83kN/m	0.83kN/m
	450mm	2.79kN/m	1.92kN/m	1.66kN/m	1.66kN/m
IHR-H	900mm	0.44kN/m	0.44kN/m	0.42kN/m	0.42kN/m
	450mm	0.89kN/m	0.89kN/m	0.84kN/m	0.84kN/m

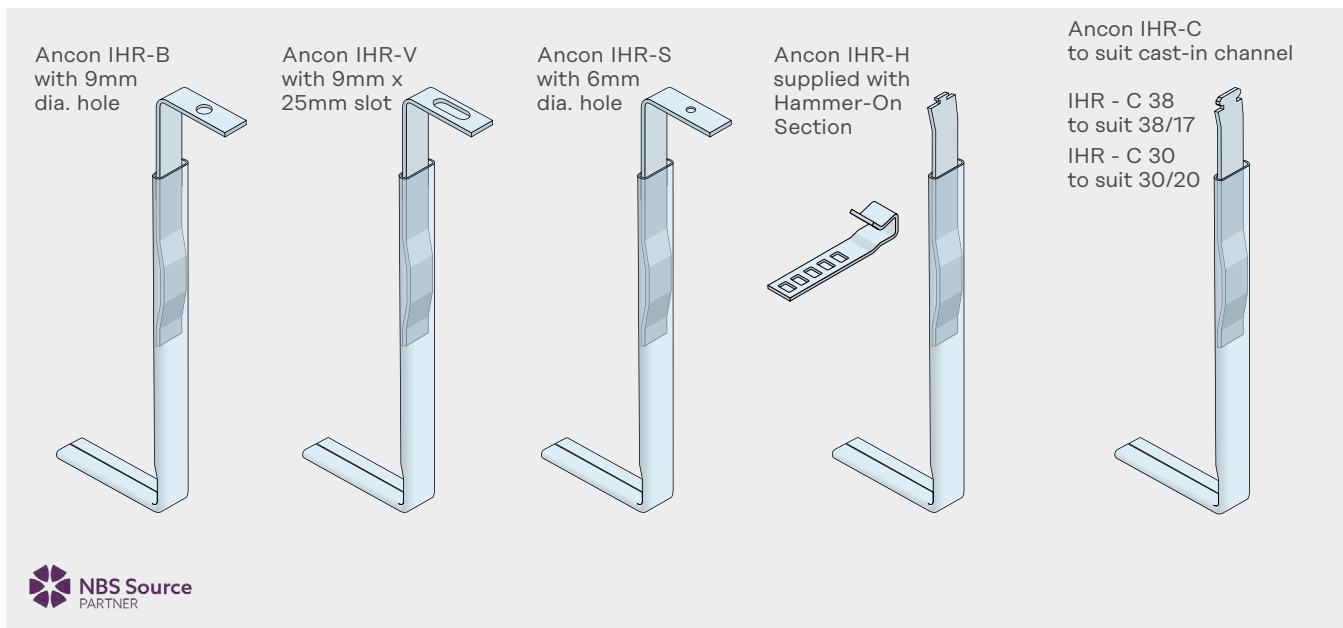

Ancon Wall Ties and Restraint Fixings



Ancon FHR - Head Restraint

The Ancon FHR Head Restraint is used for restraining the top of internal walls or the internal leaf of a cavity wall. The two angles clamp the top of the wall and have 10mm diameter holes to suit Ancon M8 bolts. They are supplied with two holes in the longer angle to allow the restraint to fit 100mm and 140mm blockwork. Each restraint provides a design resistance of 1890N. If the FHR overhangs the structure, please contact Leviat's Technical team.

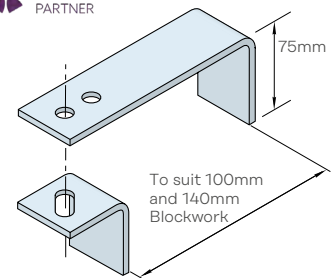

Ancon FHR Head Restraint - other sizes available

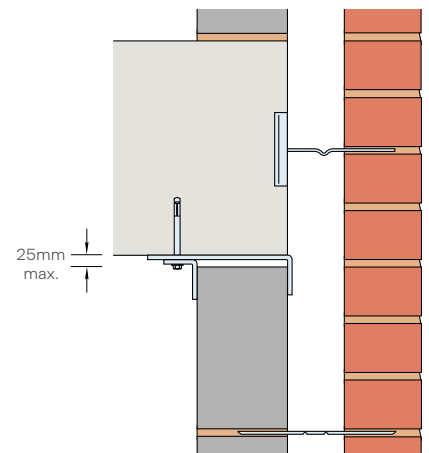

Ancon FHR Head Restraint Fixed to Underside of Floor Slab, Restraining Head of Inner Leaf of Cavity Wall

Ancon SAH - Sliding Anchors

Ancon SAH Sliding Anchors have stems which fit within the cavity and accept ties that slide to accommodate vertical movement. Available with five different head options as standard, they can be supplied with one-way or two-way ties with safety ends.

The standard fixing hole is 12mm diameter to suit Ancon M10 Expansion Bolts (concrete), Ancon M10 Set Screws (steel) or M10 T-Head Bolts to fit Ancon 28/15 Channel. When fixing the Sliding Anchor to hollow steelwork (e.g. RHS), a non-standard Ø7mm hole is required in the head to suit an SDTSS-38-5PT self-drilling self-tapping screw. Ancon SAH Sliding Anchors have a design resistance of 755N per stem when the upper tie is within 75mm of the fixing. Ties should be spaced at a minimum of 150mm and at least two ties should be used per stem.

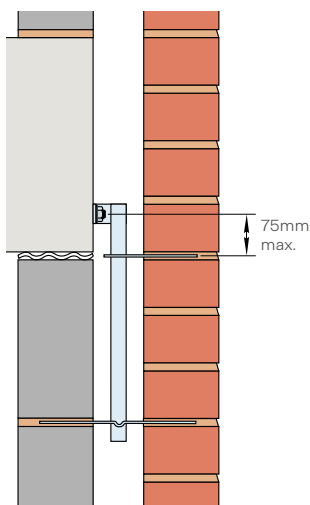
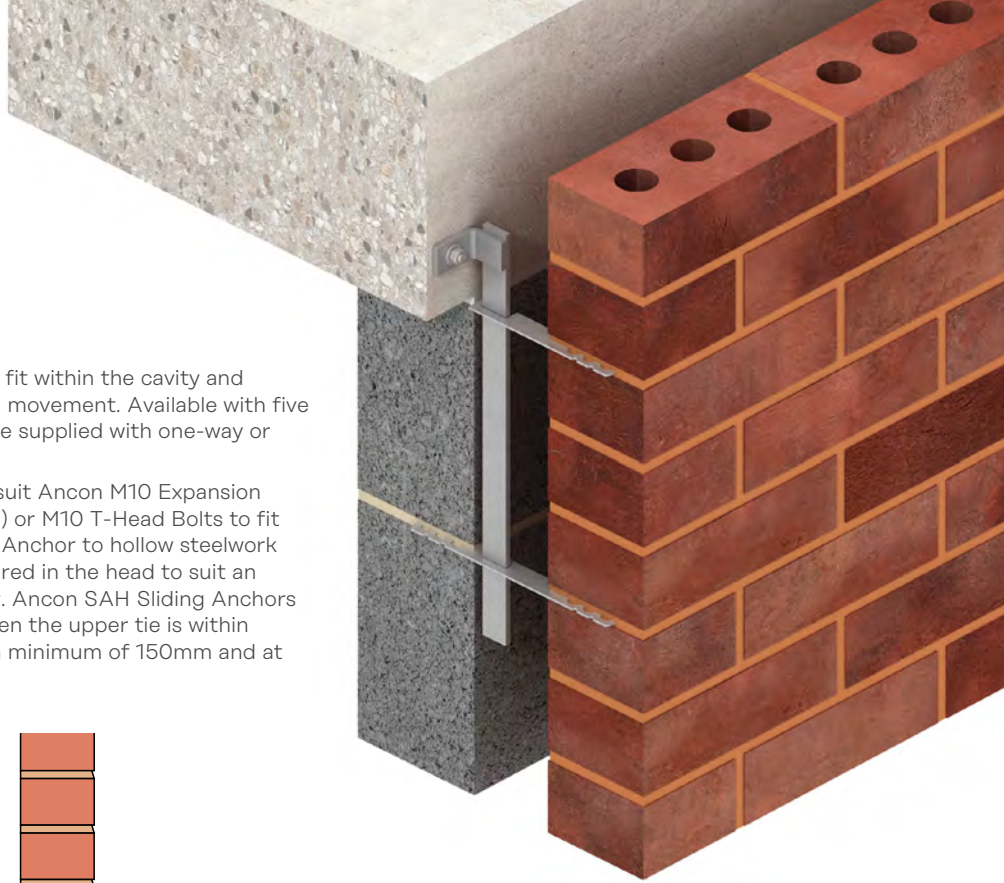

Ancon SAH - UF

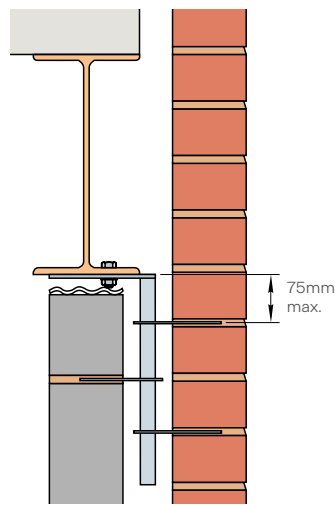

Ancon SAH - UO with Extended Head

Ancon SIS
Standard Lengths
200, 230mm
Slot is positioned
at the centre of
the tie

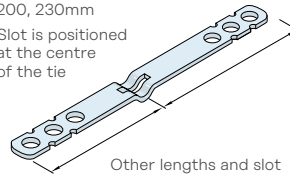

Other lengths and slot
positions available to
suit application

Ancon SPJ
Standard Lengths
135, 150mm

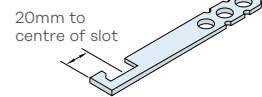

20mm to
centre of slot

Other lengths available to
suit application

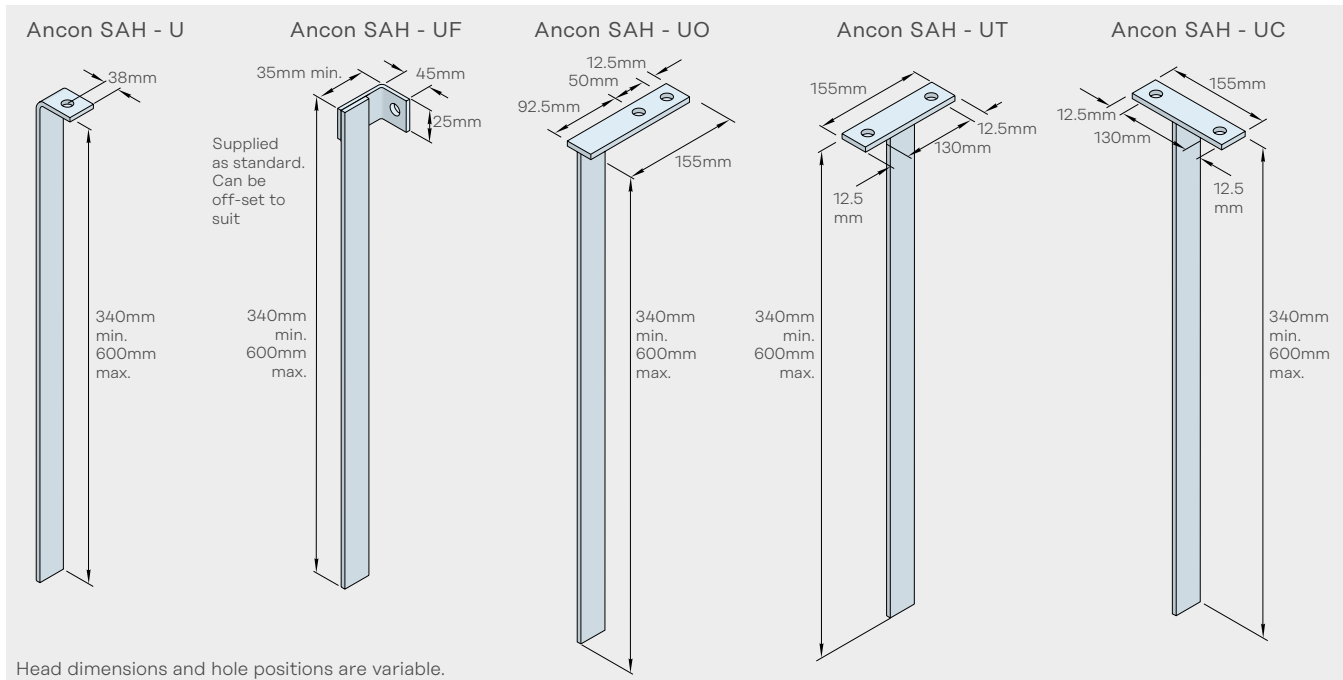

Note: These drawings are examples only. All sliding anchors are manufactured to suit individual requirements. Where sliding anchors are to be connected to a concrete frame, Leviat will provide fixings suitable for cracked concrete.

Ancon Wall Ties and Restraint Fixings

Acoustic Wall Ties

Ancon Acoustic Wall Ties feature a highly engineered, pre-compressed, acoustic isolation element. Products in this range provide the necessary structural performance, while minimising the transfer of airborne noise and vibration. Typical applications include: music rooms, recording studios, cinemas, nightclubs, industrial units, residential developments and mixed-use developments.

The acoustic performance of this range is far superior to other wall tie types and is the result of a carefully engineered balance between mechanical stiffness and high acoustic resilience. See table for comparisons.

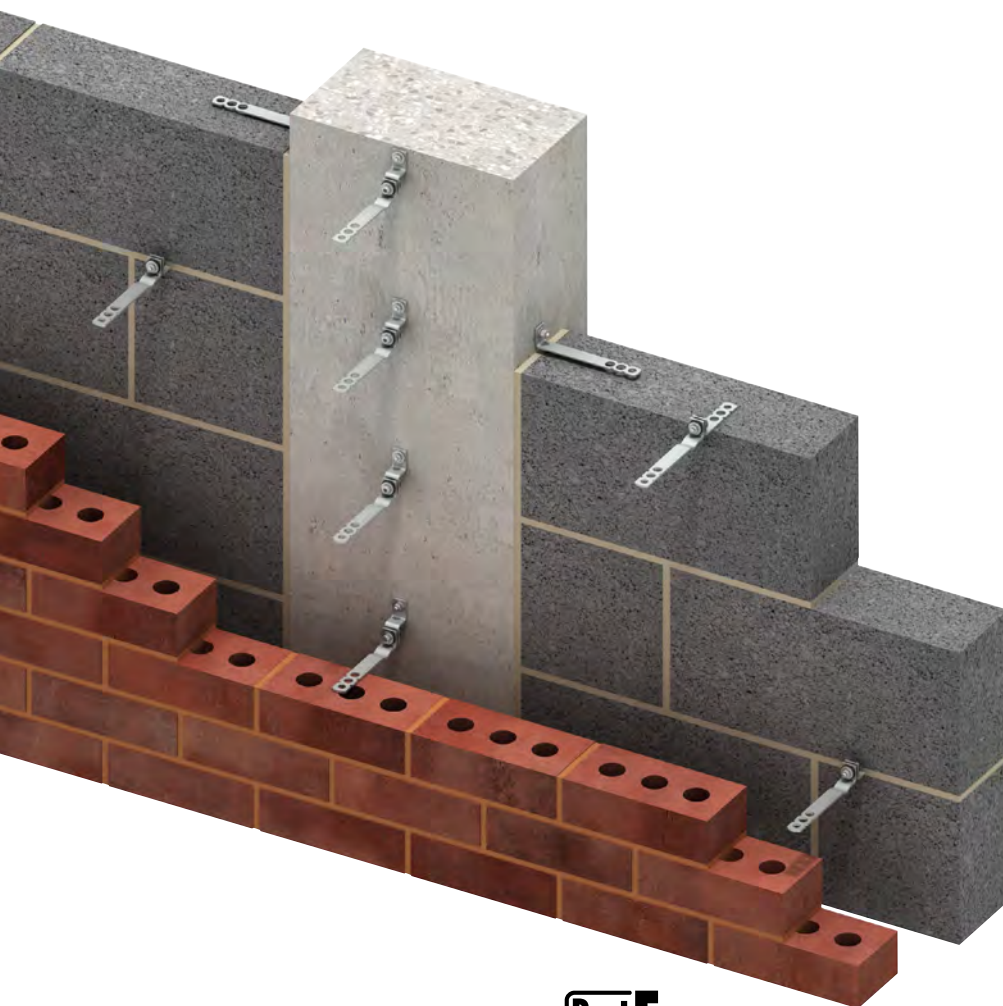

Dynamic Stiffness

Dynamic stiffness, as featured in Approved Document E of the Building Regulations, allows comparisons to be made between ties of different types and lengths. Research has shown that the dynamic stiffness of a wall tie featuring an acoustic isolator is determined by this element alone and is independent of the tie length and cavity width in which it is used (Robin Wilson, Heriot Watt University, 1992).

Approved Document E specifies the use of Type A ties in separating/party walls of new build residential developments in England and Wales. Type A ties must have a dynamic stiffness of less than 4.8 MN/m^3 . The dynamic stiffness of most Type 4 wire wall ties is only marginally below this threshold at a standard tie density of 2.5 ties/m^2 . In contrast, the Ancon Type 3 Acoustic Wall Tie range, with a comparable dynamic stiffness of just 2.15 MN/m^3 , offers a significant improvement over other Type A wall ties.

Frequency

When considering sound insulation in buildings, the range of frequencies considered are generally between 50Hz and 5000Hz and these are normally banded into the low frequency range [50 – 200Hz], mid-frequency range [201 – 1000Hz] and high frequency range [1001 – 5000Hz].

Ancon Acoustic Wall Ties have been designed to fall within the lowest band.

Structural Performance

All products in this range offer Type 3 wall tie performance to PD 6697: 2019 at a standard tie spacing of 2.5 ties/m^2 and are available in incremental lengths of 25mm to suit the cavity range stated. The table opposite shows the calculated tie density to achieve other wall tie types and how this affects the dynamic stiffness (MN/m^3). Contact us for more information.

Comparison of Acoustic Performance of Various Ancon Wall Tie Types

Wall Tie	PD 6697 Type	Cavity	Frequency*	Dynamic Stiffness**
ST1	1	50 mm	848 Hz	75.8 MN/m ³
RT2	2	50 mm	500 Hz	25.5 MN/m ³
HRT4	4	50 mm	208 Hz	4.7 MN/m ³
Acoustic Tie	3	-	139 Hz	2.15 MN/m³

*Mean axial mass-spring-mass resonance frequency of the tie

**At a standard tie density of 2.5 ties per sq.m. Test regime described in BRE information paper IP3/01.

Ancon ACOU Acoustic Range Calculated Tie Density per Wall Tie Type

Equivalent Wall Tie Type	Tie Density (Spacing)	Dynamic Stiffness	Type A
Type 4 Light Duty	2.5 ties/m² (900mm x 450mm)	2.15 MN/m³	✓
Type 3 Basic	2.5 ties/m² (900mm x 450mm)	2.15 MN/m³	✓
Type 2 General Purpose	3.9 ties/m² (565mm x 450mm)	3.35 MN/m³	✓
Type 1* Heavy Duty	7.4 ties/m² (300mm x 450mm)	6.36 MN/m³	-

For more information on wall tie types, refer to pages 7-8. * Type M2 (iv) mortar only

Acoustic Cavity Wall Ties

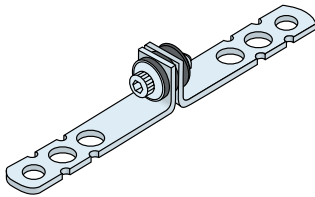

Ancon ACOU SP-SP
Plain shank cavity tie
Suits 50-175mm cavities
Available with either a central or offset isolator

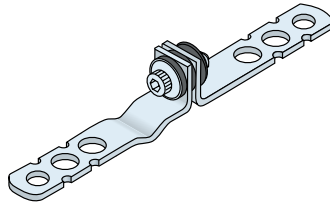

Ancon ACOU SP-SD
Cavity tie with integral drip
Suits 75-175mm cavities
Available with either a central or offset isolator

Acoustic Frame Cramps

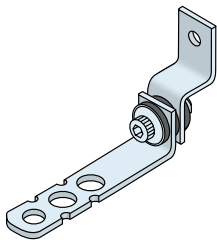

Ancon ACOU SP-ZB
Plain shank frame cramp with 7mm fixing hole
Suits 50-175mm cavities

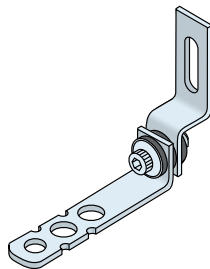

Ancon ACOU SP-ZV
Plain shank frame cramp with 8mm x 30mm fixing slot
Suits 50-175mm cavities

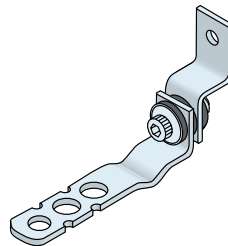

Ancon ACOU SD-ZB
Frame cramp with integral drip and 7mm fixing hole
Suits 100-175mm cavities

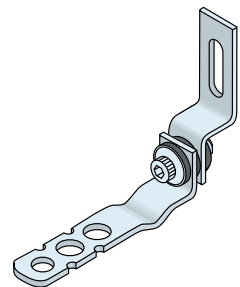

Ancon ACOU SD-ZV
Frame cramp with integral drip and 8mm x 30mm fixing slot
Suits 100-175mm cavities

Other variations are available. Please contact us with details of your application.

Ancon Wall Ties and Restraint Fixings

Wall Starter Systems

Ancon 36/8 Wall Extension System

The Ancon 36/8 Wall Extension System can be supplied with either Ancon SP36 Ties or, where some longitudinal movement must be accommodated at the joint, Ancon PP36 Ties complete with debonding sleeves. The channel can be supplied in lengths of up to 3.4 metres with each length having a series of holes to allow fixing to the existing wall. The system can accommodate wall widths of 100mm to 250mm and is available as a kit comprising ten ties, a length of Ancon 36/8 Channel 2400mm long and ten plugs and screws for fixing at 300mm vertical centres. It is suitable for fixing to blockwork or concrete and has a design resistance of 1.6kN per metre.



Ancon Staifix Universal Wall Starter System

This system includes all necessary fixings to join a single skin of masonry, 2400mm high, to an existing brickwork or blockwork wall and is suitable for wall widths from 100mm to 250mm. Each pack includes 2 fixing strips, 5 plugs, 5 washers, 5 screws and 10 wall ties. Wall Ties slide within the fixing strip to course with the bed joints of any masonry unit. This Ancon Staifix Universal Wall Starter System has a design resistance of 1.7kN per metre and can be used in line with NHBC standards.



Ancon Staifix Cavity Starter Tie

This tie simplifies the building of an inner leaf of blockwork within an existing structure. It is ideal for barn conversions. The cavity starter tie is a Type 4 tie to PD 6697: 2019.

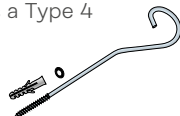

Length (mm)	Cavity (mm)	Embedment mm Masonry	Plug
180	50-70		
200	70-90	65-80	45-50
230	100-120		

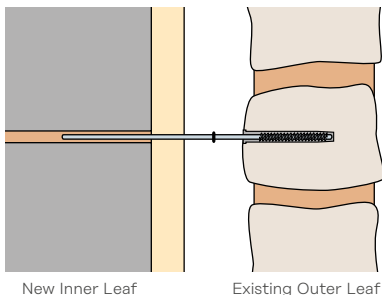

Ancon Staifix Starter Tie

This tie is quick and simple to install. It is suitable for use in brickwork and blockwork of up to 3 storeys or 8 metres in height and can be used in line with NHBC standards.

Supplied complete with an 8mm nylon wall plug, the Starter Tie is fixed into the existing wall at an angle of 30° to the horizontal and bent into the bed joints of the new brickwork. Ties should be fixed at 225mm vertical centres and be central to each leaf of the new wall.

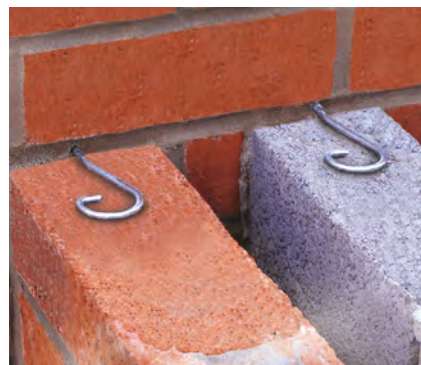
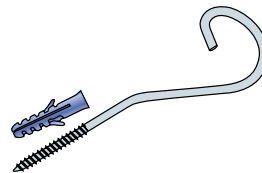

Ancon Staifix Frame Tie

The Ancon Staifix Frame Tie is used to join timber door and window frames directly to brickwork. It is designed for use on buildings of up to 15 metres in height, and can be used in line with NHBC standards. The ties are screwed horizontally into the frame, surrounded by mortar and built into the bed joints of the new brickwork.

The vertical spacing of frame ties depends on the application. Please contact us or your local Ancon Staifix stockist for more information.

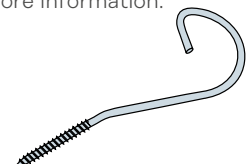

Restraints for Stone Cladding

Reference should be made to BS 8298-2: 2020 "Design and installation of natural stone cladding and lining", when selecting ties for restraining stone cladding. Restraints should be designed to resist wind loads and any imposed loads from, for example, window cleaning equipment.

Each stone will normally be restrained in four places, two at the top and two at the bottom. These are usually situated in the horizontal joints. The restraints should be located in pre-formed mortises or holes positioned in the centre of the thickness of the stone panel, and located at 1/4 points for half bonded stones and 1/5 points for stack bonded stones. Restraints should be kept at least 75mm from any corner with the peripheral distances between any two restraints not exceeding 1200mm.

The embedment of restraint dowels and lips into the stone should be at least 20mm. To achieve this, lipped ties (LPBs) have a 25mm downstand and doweled ties (DPBs and YPBs) have 60mm long dowels.

The actual capacity of the restraints will normally be restricted by the breaking load of the stone and/or the restraint fixing bolt. Breaking loads at the fixing should be determined in accordance with BS EN 13364. The stone designer is responsible for checking the dowel break-out load and that the stone is capable of spanning between the fixing locations.

Frame cramps with a B end have a 7mm diameter hole to suit a range of fixings. Ancon M6 Expansion Bolts are recommended for fixing to concrete and M6 set screws or SDTSS-38-5PT self-drilling screws for fixing to steelwork. Frame cramps can be fixed to masonry with suitable plugs and screws or resin anchors. Poor substrates will limit the capacity of fixings and site testing is advisable in such applications. All fixings should be used in conjunction with a DIN washer.



Coping Stones

For restraining horizontal coping stones, YPB ties may be used as pictured to provide nominal restraint. For copings on a slope e.g. gable ends, restraint fixings are designed to suit the requirements of the application, including the slope and size of stone. For applications involving abseiling loads or other loading arrangements, please contact our Technical Services team with details of your project for help with product selection.



Two Ancon YPB Ties Restraining Coping Stone

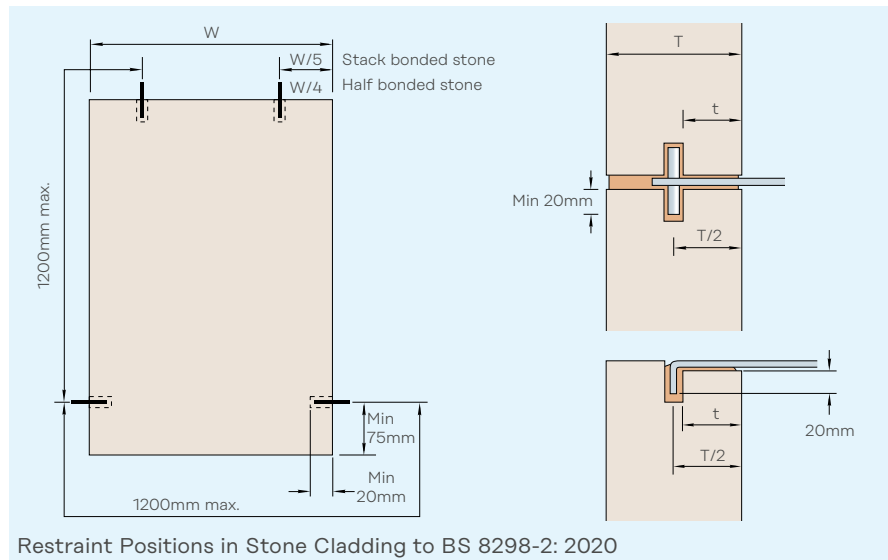

Restraint Positions in Stone Cladding to BS 8298-2: 2020



Buchanan Galleries, Glasgow

Minimum Stone Thickness 'T' and Minimum Dimension Behind Restraint 't'

Type of Stone	More than 3.7m above ground - including facias		Soffits - including inlined soffits		Sills, copings and supported reveals	
	T (mm)	t (mm)	T (mm)	t (mm)	T (mm)	t (mm)
Granite, slate, white marble, quartzites	40	15	40	15	30	12
Hard limestone, travertines	40	15	40	15	30	12
Limestone, sandstone	75	30*	75	30*	50	20

* t = T/2 if stone thickness (T) is greater than 75mm

Ancon Wall Ties and Restraint Fixings

Section of Ties

Restraints for large stones and for use where cavities are in excess of 100mm may require special attention. They may need a much bigger section than standard 20 x 2.5mm; ties formed from 20 x 3mm, 25 x 3mm, 30 x 3mm and 30 x 4mm are frequently used for restraining stone cladding.

Minimum Section of Dowels

Stone Thickness	Minimum Diameter of Dowels
30mm and below	3mm
40mm	5mm
50mm and above	6mm

Drip Position

If a drip is required (e.g. YDB) please specify the position, indicating from which end of the tie the measurement is taken.

Dowels

Standard dowels are 6mm in diameter and 60mm long. These will be welded into the tail end of ties referenced D___, and supplied loose with ties referenced Y___ and the multi-holed M___. 8mm and 10mm diameter dowels are also available upon request, as are longer lengths.

Wire Ties

The traditional method of fixing thin marble, particularly for internal linings and low rise cladding is with wire ties and plaster or mortar dabs. Wire ties are manufactured from 3mm diameter wire.

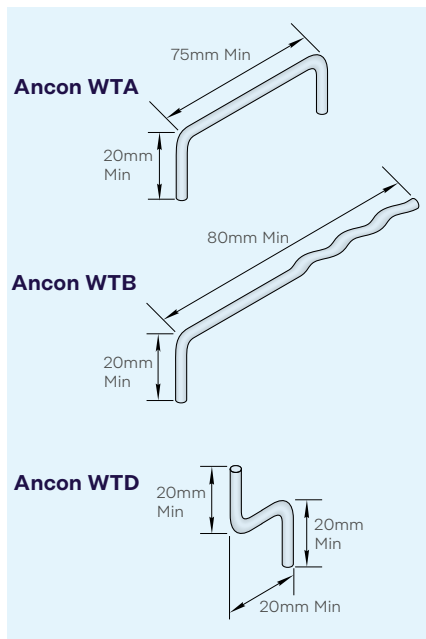

Ancon LD21 Ties Fixed into Ancon 21/18 Omega Channel, Restraining Top of Stone

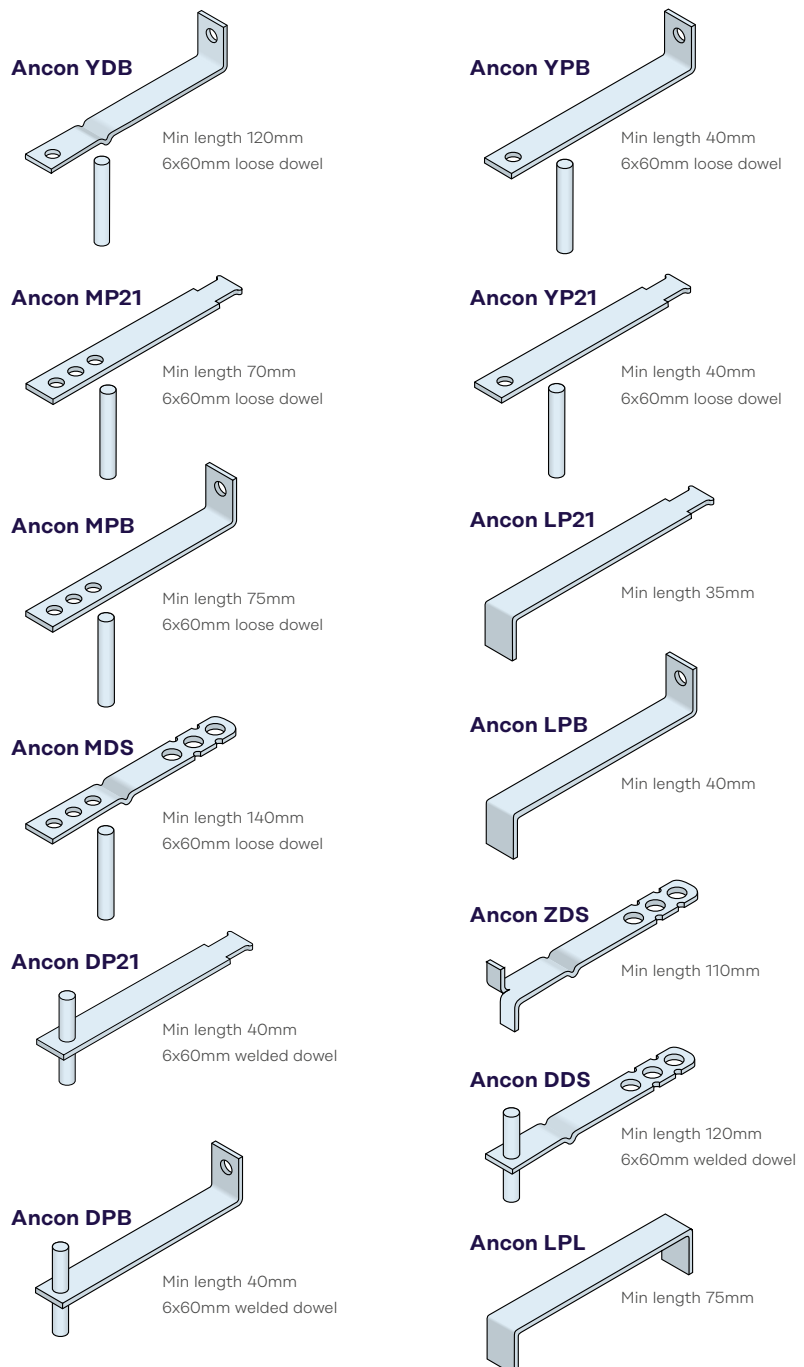

Remedial Wall Ties

Corrosion of Cavity Wall Ties

Wall ties are an essential element in the stability of masonry panels. Prior to 1978, wall ties were usually manufactured from galvanised mild steel. These ties were expected to last the lifetime of the building, but it has now been recognised that these wall ties can corrode after only 15 or 20 years.

When these ties corrode, they can expand to seven times their original thickness. This causes the brickwork to crack at the mortar joints and can result in major damage and sometimes the collapse of walls.

It is crucial that the problem is identified as quickly as possible and the correct remedial action undertaken.

Testing and Tie Performance

The '63 range, Ancon Staifix R/R and Ancon Teplo-R have been independently tested in a variety of materials; a summary of the results is given in the tables. The failure loads noted are obtained from standard tests in brick couplets and provide indicative values of tie performance. The couplet test produces results of a conservative nature compared to actual wall tests. Due to the variability of materials, it is advisable to undertake a pull-out test on site to verify the selection of an appropriate tie. Ancon Remedial Wall Ties do not carry product marking as the test regime in the European Standard EN 845-1 is inappropriate for remedial applications.

Tie Spacing

Accepted practice is to follow PD 6697: 2019; that is maximum 900mm horizontally and 450mm vertically in a staggered pattern with 300mm vertical centres around openings within 225mm of the opening. Spacing should be determined by site testing of ties with a minimum density of 2.5 ties per m².

Fischer FIS-V Plus S Resin

This CE-marked, two part system of vinyl ester and hardener, is quick setting and suitable for a wide range of applications. An extension nozzle will be required when resin fixing remedial wall ties in the inner leaf of a cavity wall. Dispenser guns and additional static mixing nozzles are available.



Corroded Steel Wall Tie



Ancon 63 Setting Tool

Installation of Remedial Wall Ties

Mechanical ties are easily installed by means of a Setting Tool which expands the brass ends in a drilled hole.

To install RM, Ancon Staifix Resin/Resin and Ancon Teplo-R remedial wall ties an extension nozzle and tube is required to pump resin across the cavity and into the inner leaf. The extension tube is supplied in a standard length of 1000mm and is cut to suit on site.

Installation guides are available to download from www.ancon.co.uk.

Ancon MM63 Setting Tools

Inner Tool

Outer Tool

Ancon RM 63 Range (Resin/Mechanical)

Drill (mm)	Drill Depth (Inner Leaf) (mm)	Tie Length (mm)	Nominal Cavity Width (mm)	Stock or Accrington Brick	Ultimate Tensile Load (kN)				
					Common Brickwork	Dense Concrete Block-work	Light-weight Concrete Block-work	40N Concrete	30N Concrete
11	70-75	200	35-60	3.3	3.0	2.6	2.1	3.2	2.9
		225	61-85						
		250	86-110						
		300	135-160						

Note: For cavities in the range 111mm to 134mm we recommend a Resin/Resin tie. Ties should not be positioned less than 10mm from the weather side of the outer leaf. Minimum embedment to the inner leaf is 70mm.

Ancon MM 63 Range (Mechanical/Mechanical)

Drill (mm)	Drill Depth (Inner Leaf) (mm)	Tie Length (mm)	Nominal Cavity Width (mm)	Ultimate Tensile Load (kN)		
				Common Brickwork	Dense Concrete Blockwork	30N Concrete
11	55-65	200	45-70	6	3	8
		225	71-95			
		250	96-120			
		300	145-170			

Failure Loads (Pull-Out) for Ancon Staifix R/R

Base Material	Compressive Strength (N/mm ²)	Failure Load (kN)
Dense Concrete Block	7.0-10.5	5.78
Lightweight Concrete Block	2.8-3.5	2.87
Mortar Bed Joint, 1:1:6 Type (iii) PD 6697: 2019	-	5.37

Ancon Teplo-R

Cavity Widths (mm)	Tie Lengths (mm)	Drill Diameter (mm)	Tie Diameter (mm)
75-450	215-590	10	7

Failure Loads (Pull-Out) for the Ancon Teplo-R

Base Material	Embedment (mm)	Ø7mm Tie Failure Load (kN)
Brick (20N/mm ²)	70	4.73
Aerated Concrete Block (3.6N/mm ²)	70	2.27
Foundation Concrete Block (7.3N/mm ²)	70	2.29
Dense Concrete Block (C25/30)	70	11.90

Note: The failure loads given are pull-out tests only. The overall performance of the tie may be limited by other factors. For reduced embedment or alternative substrates, we recommend a site tensile test is conducted to ascertain actual performance. For further information please contact our Technical team to confirm suitability for specific applications.

Ancon Wall Ties and Restraint Fixings

Ancon 63 Mechanical/Mechanical

Used when tying together two leaves of solid materials, this tie has mechanical expanders at each end. Requires 12mm Ø holes.

Ancon 63 Resin/Mechanical

For use when the material in the inner leaf is perforated, of low-density or a friable material. A resin fixing may be used to eliminate any imposed stress. Requires 11mm Ø holes.

Ancon Staifix Resin/Resin

Used where mechanical expanders are unusable. Normally inserted into a 10mm Ø hole, but if test facilities are required, a 12mm Ø hole must be used. A plastic sieve can be used to retain resin and is particularly useful in perforated brick or hollow blockwork. A 12mm Ø hole is required to fit the sieve.

Ancon Stairib Bar

Stainless steel ribbed bar, resin-grouted into the inner and outer leaves. Requires 10mm Ø hole (6mm dia. bar) or 12mm Ø hole (8mm dia. bar).

Ancon AC 31

Used where bricks are removed then replaced in the outer leaf. The wavy end is resin-bonded into the inner leaf in a 10mm Ø hole. The triangular end sits in the bed joint. Ancon AC 31 is supplied with a moveable neoprene o-ring that acts as a drip.

Ancon AC 31C

Similar to the Ancon AC 31 but cranked by 25mm to aid fixing to the inner leaf. Requires 10mm Ø holes.

Ancon Teplo-BFR

Basalt fibre wall tie featuring a plain end for anchoring in resin and a moulded safety end for building into a bed joint. This tie has a thermal conductivity of only 0.7 W/mK. Requires Ø10mm hole (to suit Ø7mm bar).

Ancon Teplo-R

This plain-ended basalt fibre wall tie can be resin-fixed in remedial and retrofit applications. This tie has a thermal conductivity of only 0.7 W/mK. Requires Ø10mm hole (to suit Ø7mm bar).

Ancon HRT4/R

Used for tying the two leaves of a cavity wall or separating wall where the first leaf has already been built. The wavy end is resin-bonded into the existing wall in a 10mm Ø hole. Both ends of the tie should be embedded by at least 62.5mm. The tie is based on the Ancon Staifix HRT4 and has similar properties.

Ancon Type A R/R

This tie is designed as a remedial tie for a separating wall. It will normally be inserted in 10mm diameter holes and resin-bonded into both leaves. Both ends of the tie should be embedded by at least 62.5mm. It meets the requirements of a Type A wall tie to Approved Document E.

Ancon MM 63

200mm for 45-70mm cavities
225mm for 71-95mm cavities
250mm for 96-120mm cavities
300mm for 145-170mm cavities



Ancon RM 63

200mm for 35-60mm cavities
225mm for 61-85mm cavities
250mm for 86-110mm cavities
300mm for 135-160mm cavities



Ancon Staifix R/R

180mm for 40-60mm cavities
200mm for 61-80mm cavities
220mm for 81-100mm cavities
240mm for 101-120mm cavities
260mm for 121-140mm cavities
280mm for 141-160mm cavities



Ancon Stairib Bar

Length to order
6, 8mm dia.



Ancon AC 31

Lengths 175, 200, 225, 250, 275, 300mm



Ancon AC 31C

Lengths 175, 200, 225mm



Ancon Teplo-BFR

Lengths 210-585mm

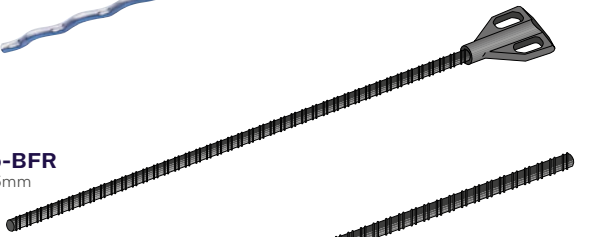

Ancon Teplo-R

Lengths 215-590mm



Ancon HRT4/R

Lengths 200, 225, 250mm

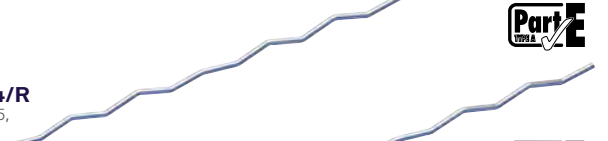

Ancon Type A R/R

Length 225mm

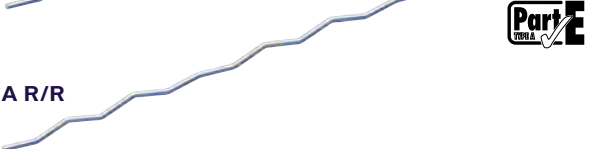

Note: For both the Ancon HRT4/R and Type A R/R, the presence and spacing of any existing ties needs to be carefully considered to ensure Type A is still achieved.

Ancon Staifix-Thor Helical Crack Stitching Kit

The Ancon Staifix-Thor Helical Crack Stitching Kit is a high strength, non-disruptive solution for the permanent repair of cracked masonry. It is available from builders merchants and specialist distributors.

Ideal for either the remedial specialist or the contractor with a one-off repair job, the kit contains 10 Ancon Staifix-Thor Helical reinforcing bars (6mm x 1000mm), masonry repair grout (3 litres), a paddle for grout mixing, a grout applicator gun with a flat nozzle and a finger trowel.



Purchase of the kit, in preference to obtaining all the components individually, guarantees the correct specification and compatibility of reinforcement, grout and tools for this specific application. The kit is supplied in a single box with full installation instructions.



The stainless steel helical bars are chemically bonded into bed joints to stitch cracks, redistributing tensile forces and stabilising the structure. On completion, the bar and grout are concealed, retaining the original character of the wall.

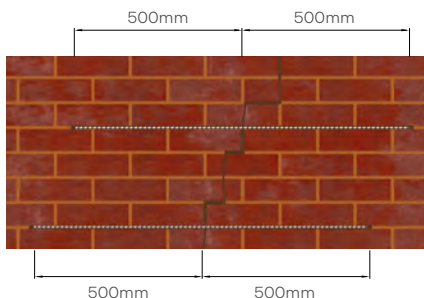

Please note it is essential that the cause of the cracking is established and eliminated prior to the installation of this system.

Other Ancon Products

Masonry Support Systems

Masonry cladding on concrete or steel frames is normally supported from stainless steel support systems. Ancon Optima and Ancon MDC Systems create a continuous angle to support the outer leaf of masonry. Ancon Individual Brackets support masonry features such as curves and arches. A full design service is available to specifiers and users of Ancon Systems.



Masonry Reinforcement

Ancon AMR Masonry Reinforcement improves the structural performance of a wall by providing additional resistance to lateral loads. Located in the bed joint, it has a flattened profile to maintain good mortar cover even when lapped or used with wall ties. It is available in various standard configurations to suit a range of loading conditions and wall widths.



Windposts and Parapet Posts

Large panels of masonry or panels with openings can often be difficult to justify structurally. Ancon Windposts are designed to provide additional lateral support for panels of brickwork. The range is manufactured from stainless steel and includes Windposts which can be installed into the inner leaf of blockwork and Windposts for installation into the cavity, which leave the blockwork undisturbed. Parapet Posts are used as vertical support for brickwork in either parapet or spandrel panels.



Insulated Balcony Connections

Ancon Thermally Insulated Connectors minimise heat loss at balcony locations while maintaining structural integrity. They provide a thermal break and, as a critical structural component, transfer moment, shear, tension and compression forces. Standard solutions are available for concrete-to-concrete, steel-to-concrete and steel-to-steel interfaces.

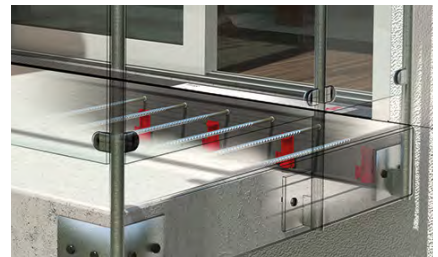

Halfen Tension and Compression Systems

The use of tie bars in structures and buildings as an architectural as well as a structural element is increasing. Halfen Tension Systems comprise a range of components which can be supplied in carbon steel or stainless steel in a variety of sizes and finishes. The system looks particularly impressive when used with large areas of glazing or timber trusses.



For BIM objects of the above products visit www.ancon.co.uk/BIM or NBS Source



Contact Leviat locally

For more information on the products featured here, please contact Leviat:

United Kingdom

Sheffield

President Way,

President Park,

Sheffield S4 7UR

Tel: +44 - 114 275 5224

Email: info.uk@leviat.com

Contact Leviat worldwide

Australia

98 Kurrajong Avenue,
Mount Druitt, Sydney, NSW 2770
Tel: +61 - 2 8808 3100
Email: info.au@leviat.com

Austria

Leonard-Bernstein-Str. 10
Saturn Tower, 1220 Wien
Tel: +43 - 1 - 259 6770
Email: info.at@leviat.com

Belgium

Industrielaan 2
1740 Ternat
Tel: +32 - 2 - 582 29 45
Email: info.be@leviat.com

China

Room 601 Tower D,
Vantone Centre
No. A6 Chao Yang Men Wai Street
Chaoyang District
Beijing P.R. China 100020
Tel: +86 - 10 5907 3200
Email: info.cn@leviat.com

Czech Republic

Pekařská 695/10a
155 00 Praha 5
Tel: +420 - 311 - 690 060
Email: info.cz@leviat.com

Finland

Vädursgatan 5
412 50 Göteborg / Sweden
Tel: +358 (0)10 6338781
Email: info.fi@leviat.com

France

6, Rue de Cabanis
31240 L'Union
Tel: +33 (0)5 34 25 54 82
Email: info.fr@leviat.com

Germany

Liebigstrasse 14
40764 Langenfeld
Tel: +49 - 2173 - 970 - 0
Email: info.de@leviat.com

India

Unit S4, 902, A Wing,
Lodha iThink Techno Campus Building,
Panchpakhadi, Pokharan Road 2,
Thane, 400606
Tel: +91-022 695 33700
Email: info.in@leviat.com

Italy

Via F.lli Bronzetti 28
24124 Bergamo
Tel: +39 - 035 - 0760711
Email: info.it@leviat.com

Malaysia

28 Jalan Anggerik Mokara 31/59
Kota Kemuning,
40460 Shah Alam Selangor
Tel: +603 - 5122 4182
Email: info.my@leviat.com

Netherlands

Slachthuisweg 10
7556 AX Hengelo
Tel: +31 - 74 - 267 14 49
Email: info.nl@leviat.com

New Zealand

246D James Fletcher Drive, Otahuhu,
Auckland 2024
Tel: +64 - 9 276 2236
Email: info.nz@leviat.com

Philippines

27F Office A, Podium West Tower,
12 ADB Avenue, Ortigas Center
Mandaluyong City, 1550
Tel: +63 - 2 7957 6381
Email: info.ph@leviat.com

Poland

Ul. Obornicka 287
60-691 Poznań
Tel: +48 - 61 - 622 14 14
Email: info.pl@leviat.com

Singapore

10 Benoi Sector,
Singapore 629845
Tel: +65 - 6266 6802
Email: info.sg@leviat.com

Spain

Poligono Industrial Santa Ana
c/ Ignacio Zuloaga, 20
28522 Rivas-Vaciamadrid
Tel: +34 - 91 632 18 40
Email: info.es@leviat.com

Sweden

Vädursgatan 5
412 50 Göteborg
Tel: +46 - 31 - 98 58 00
Email: info.se@leviat.com

Switzerland

Grenzstrasse 24
3250 Lyss
Tel: +41 (0)800 22 66 00
Email: info.ch@leviat.com

United Arab Emirates

RA08 TB02, PO Box 17225
JAFZA, Jebel Ali, Dubai
Tel: +971 (0)4 883 4346
Email: info.ae@leviat.com

United Kingdom

President Way,
President Park,
Sheffield S4 7UR
Tel: +44 - 114 275 5224
Email: info.uk@leviat.com

USA / Canada

6467 S Falkenburg Road
Riverview, FL 33578
Tel: (800) 423-9140
Email: info.us@leviat.us

For countries not listed
Email: info@leviat.com

Notes regarding this document

© Protected by copyright. The information in this publication is based on state-of-the-art technology at the time of publication. In every case, project working details should be entrusted to appropriately qualified and experienced persons. Leviat shall not accept liability for the accuracy of the information in this document or for any printing errors. We reserve the right to make technical and design changes at any time. With a policy of continuous product development, Leviat reserves the right to modify product design and specification at any time.

Leviat®

Imagine. Model. Make.

Leviat.com